

TOP SIDE

21 2 X PCIE Gen 2.0/SATA3.0
(40 Pin FPC Connector)

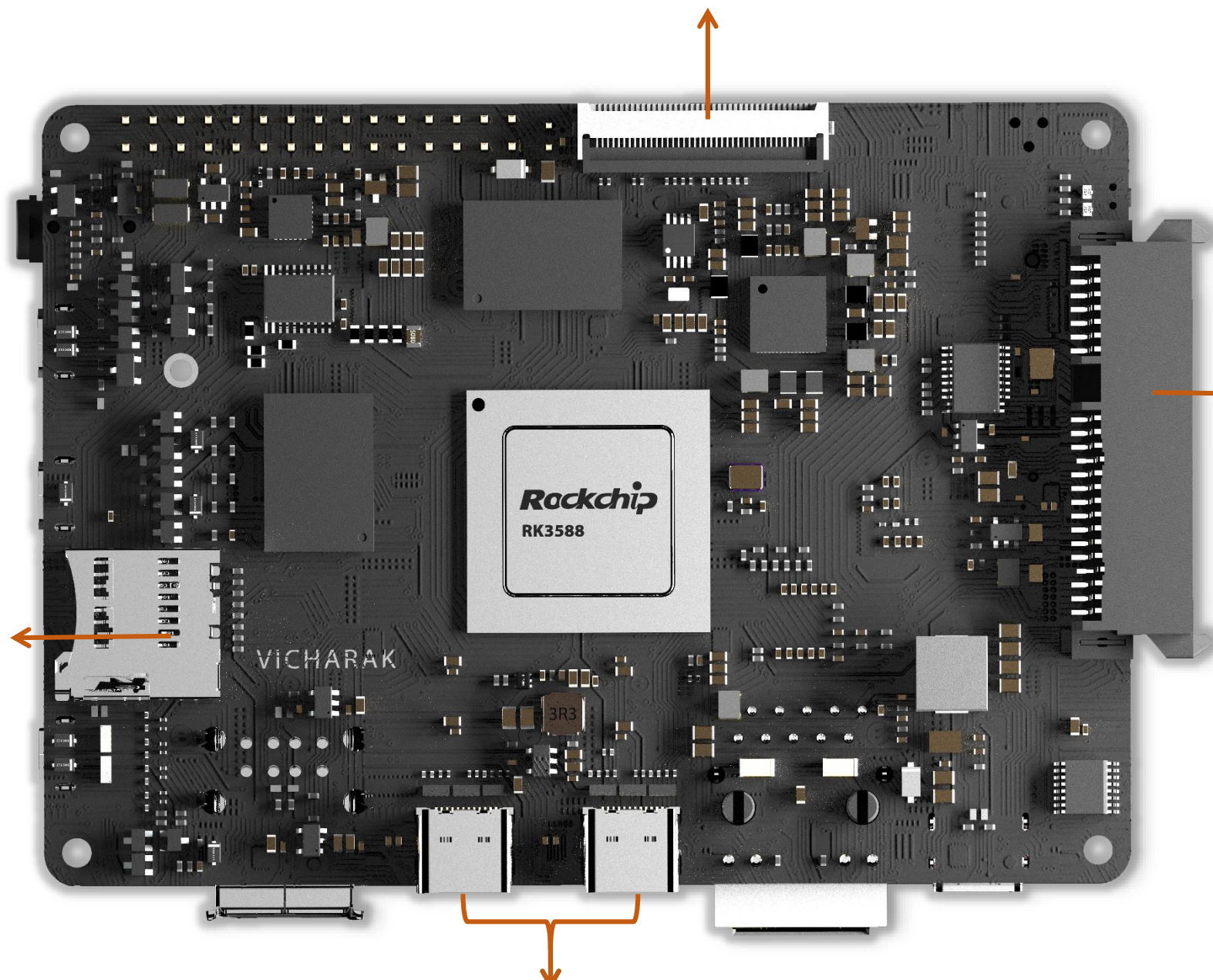

24 1 X SATA3.0
(22 pin Standard
SATA Connector)

22 SD Card Slot

23 2 X Type-C Alt Display Port

BOTTOM SIDE

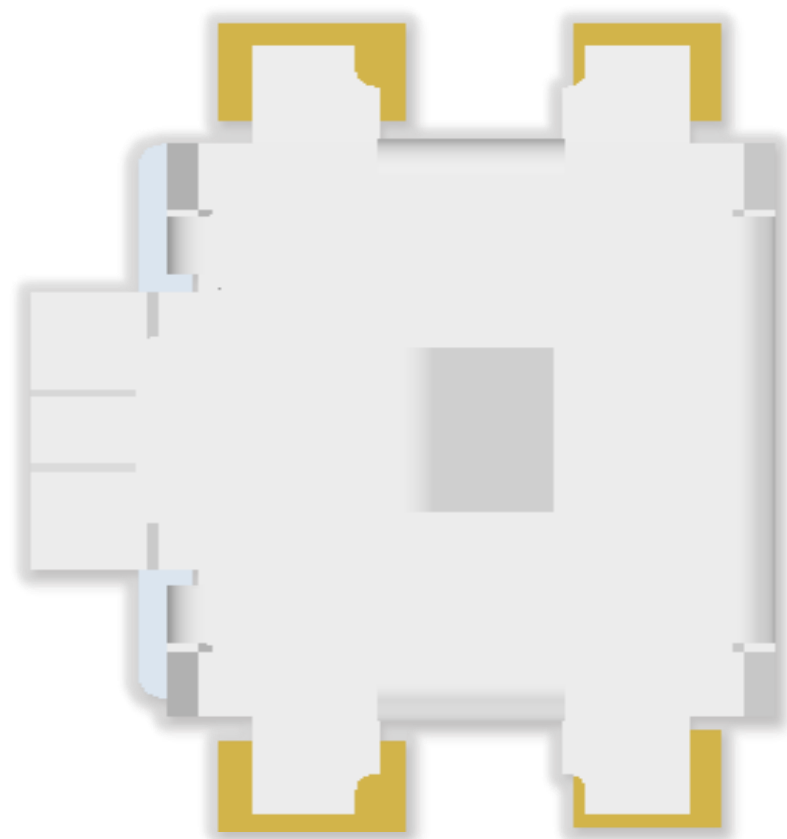

Maskrom Key

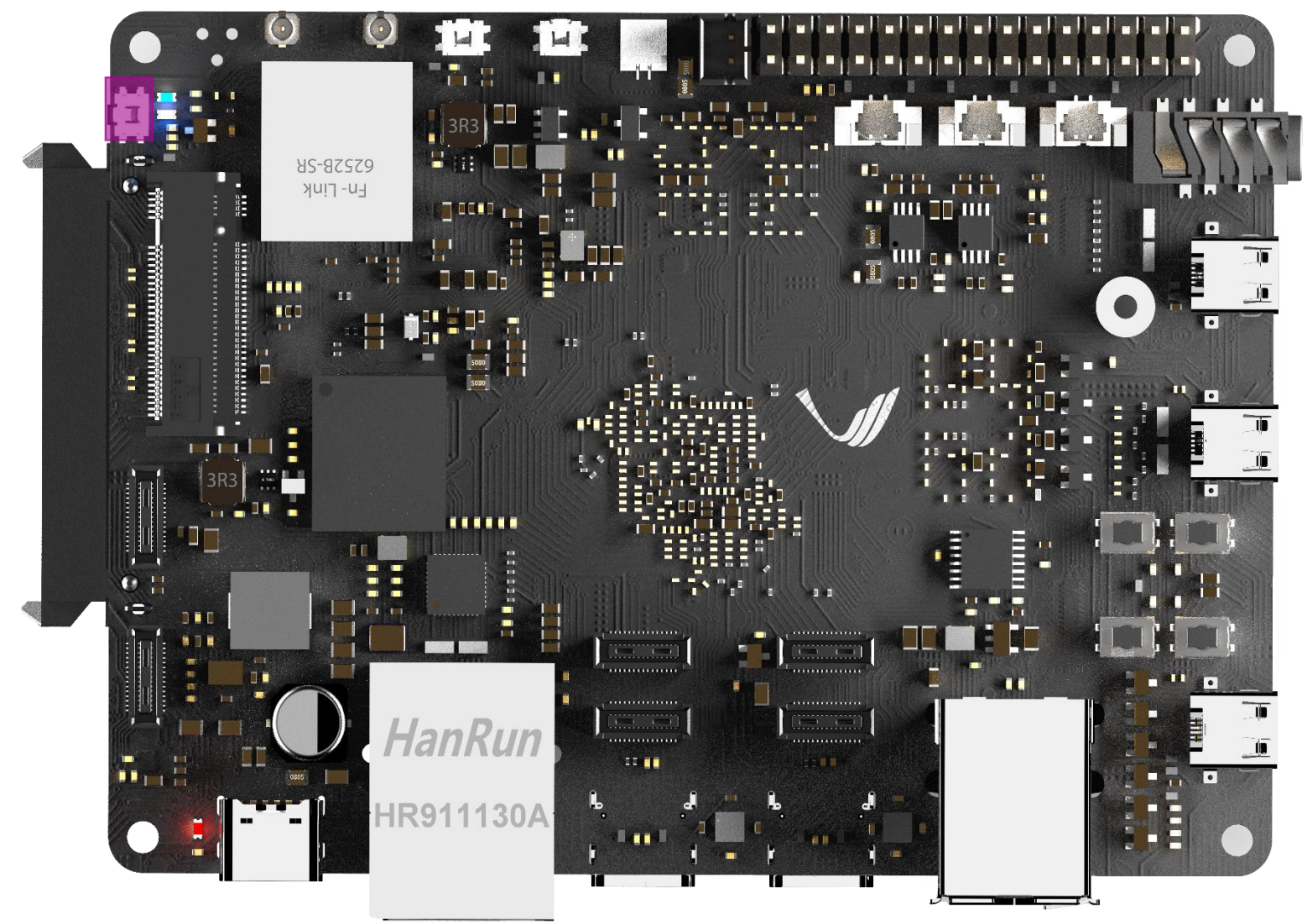

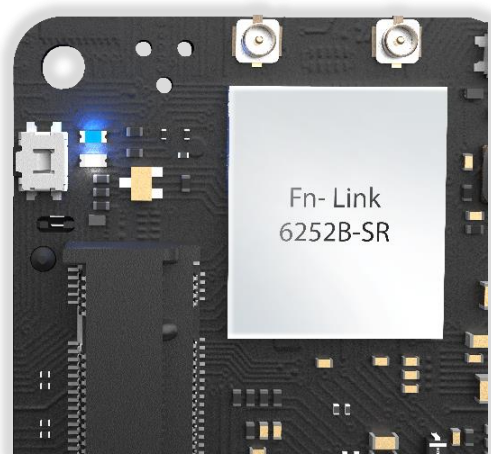

- 1. User LED
- 2. Status LED

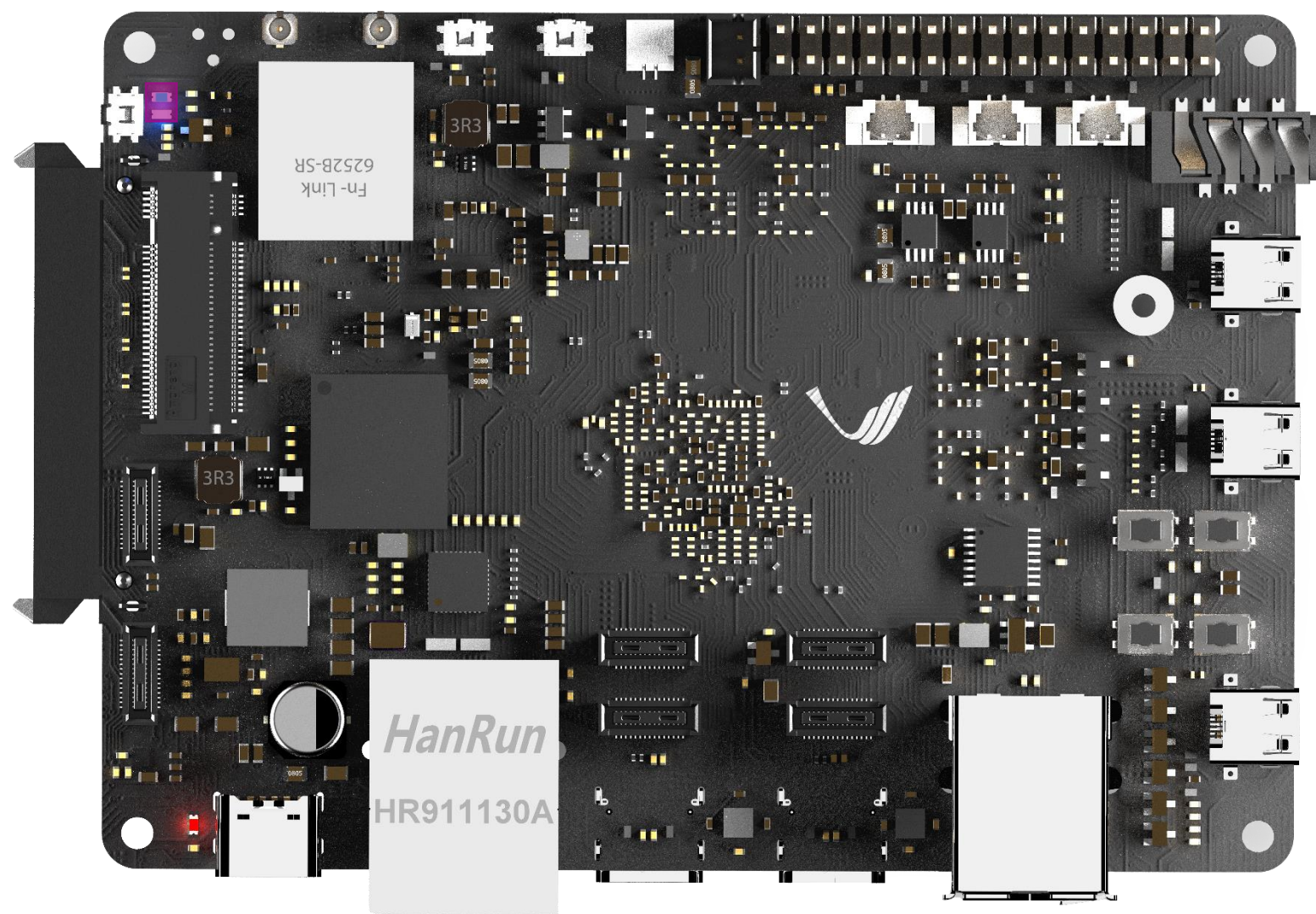



**NVME M.2 M-Key
PCIe Gen3**

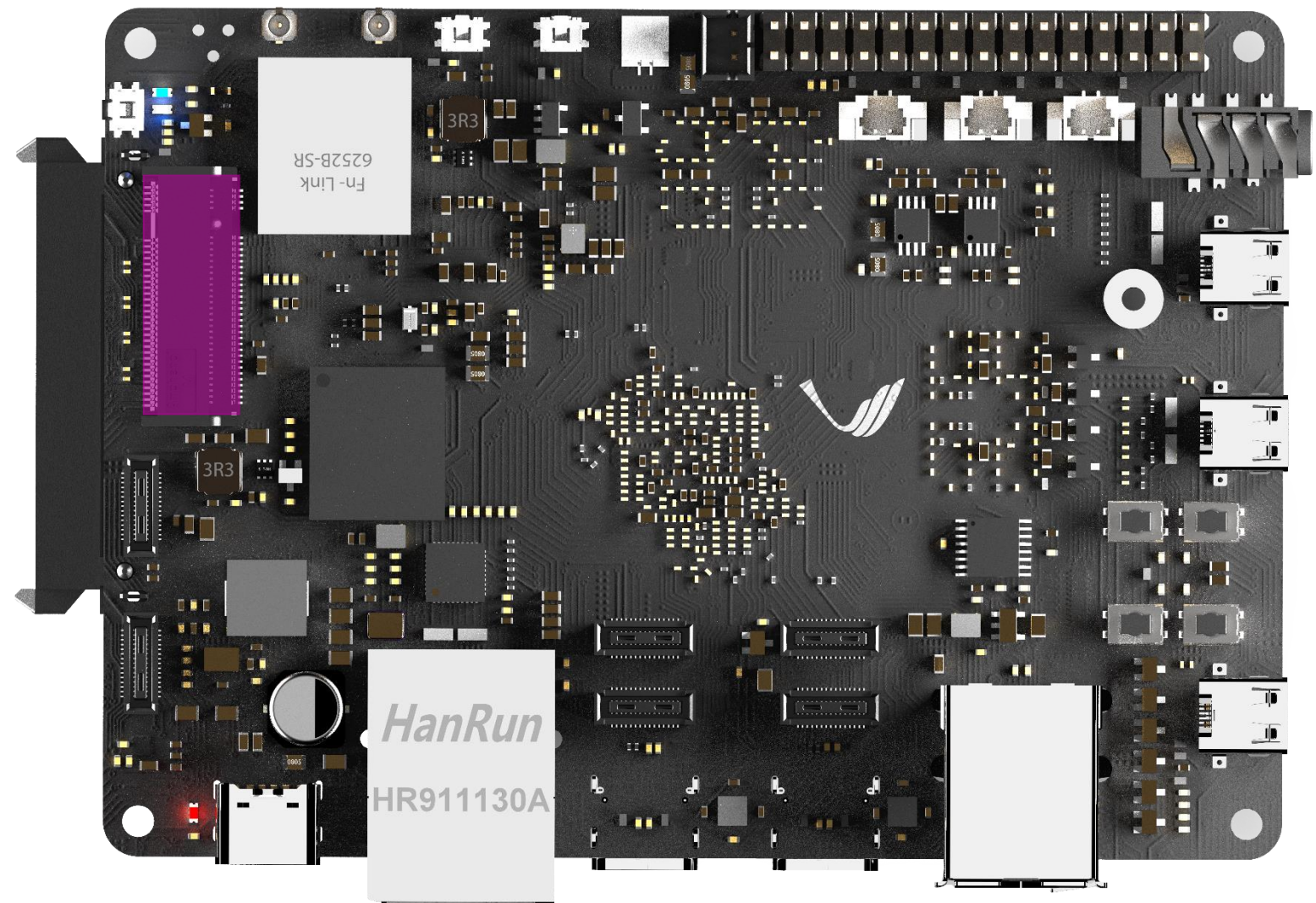

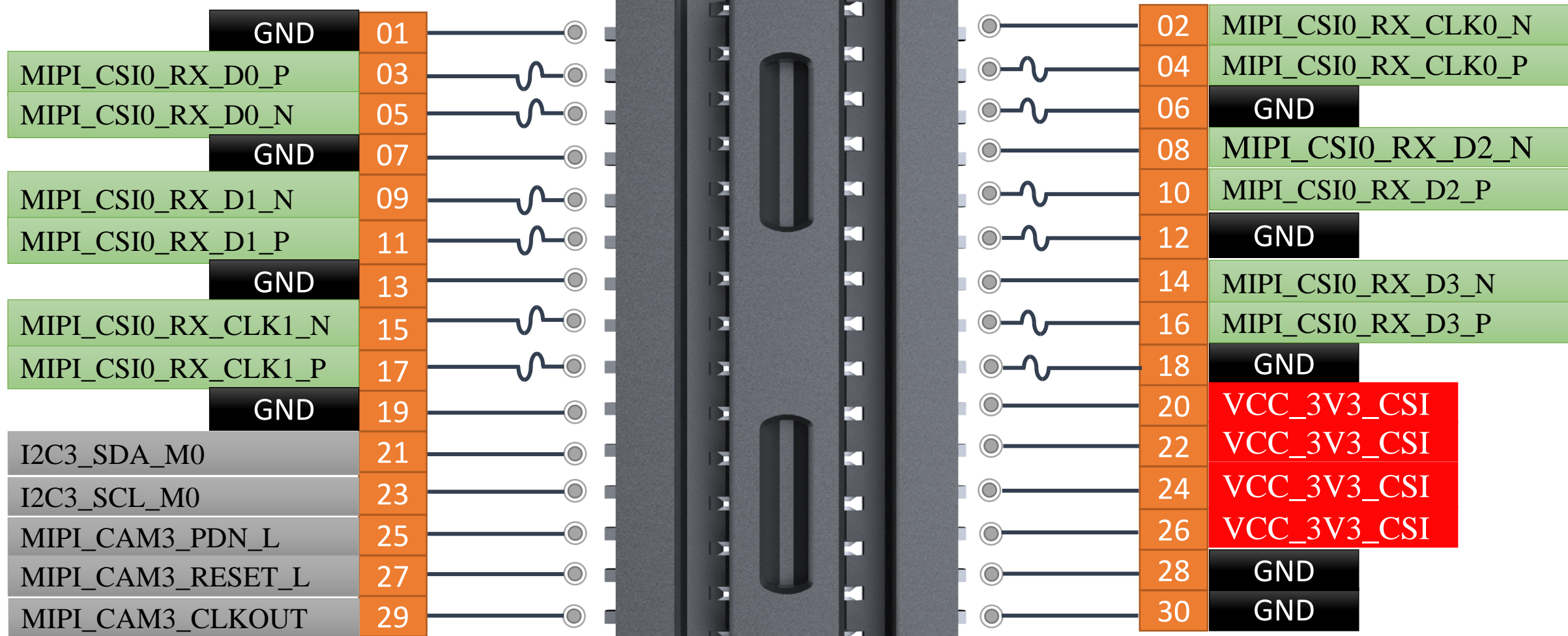

MIPI CSI RX0

On-Board Connector

30 Pin
 0.4mm Pitch
 MPN : DF40HB(2.0)-30DS-0.4V(51)

Mating Connector

30 Pin
 0.4mm Pitch
 MPN : DF40C-30DP-0.4V(51)

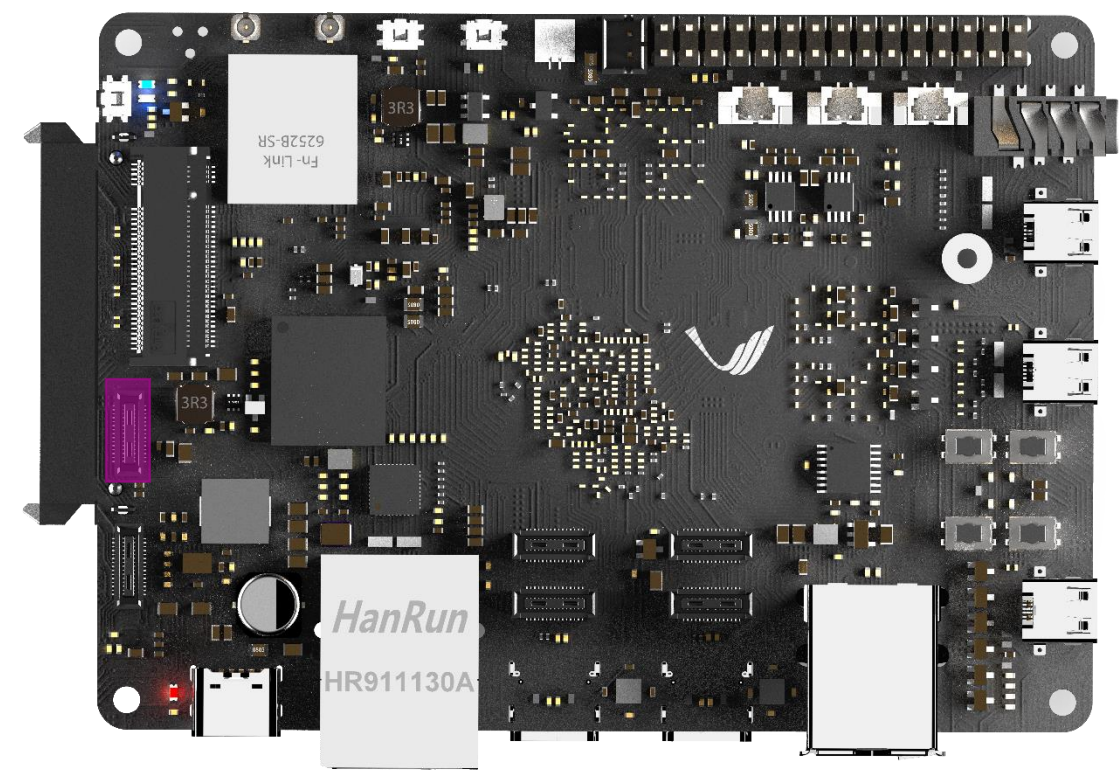

MIPI CSI RX PORT1

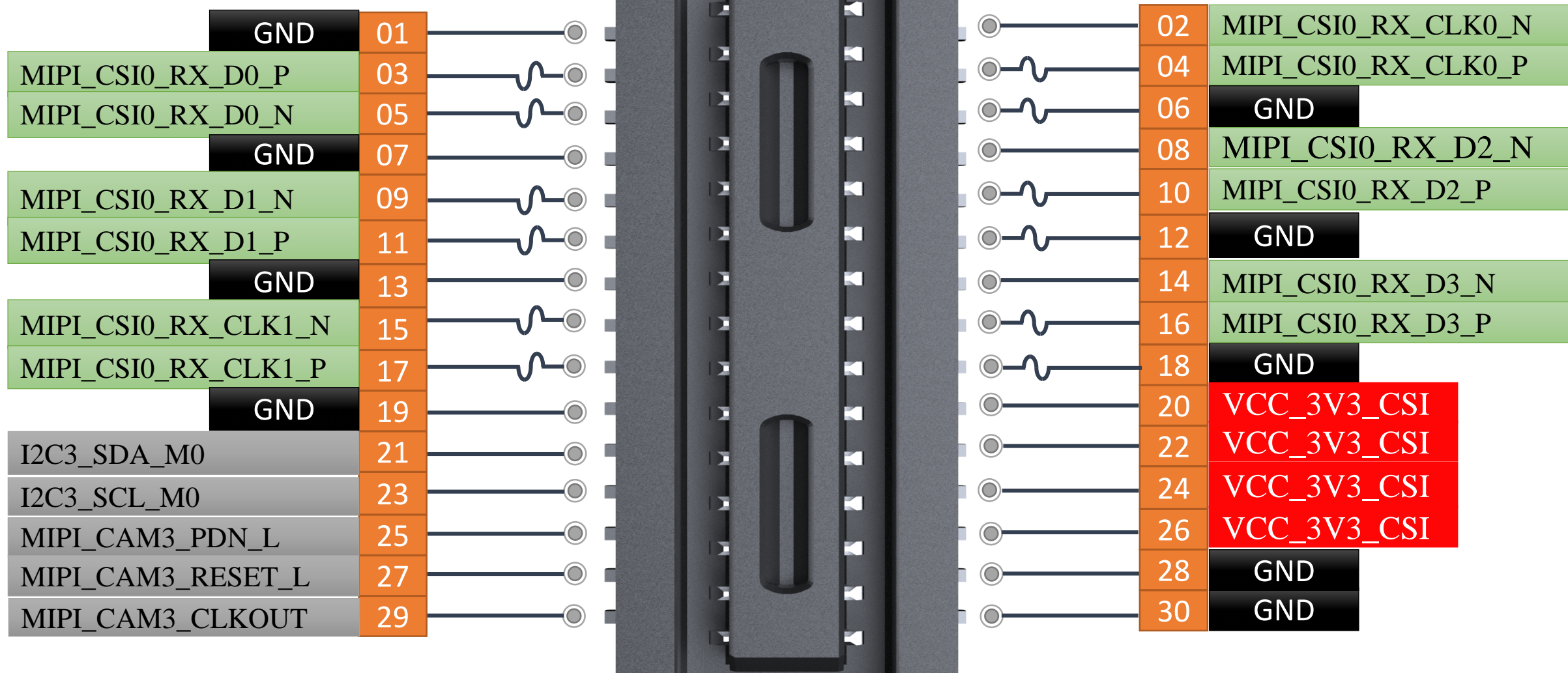

MIPI CSI RX1

On-Board Connector

30 Pin
 0.4mm Pitch
 MPN : DF40HB(2.0)-30DS-0.4V(51)

Mating Connector

30 Pin
 0.4mm Pitch
 MPN : DF40C-30DP-0.4V(51)

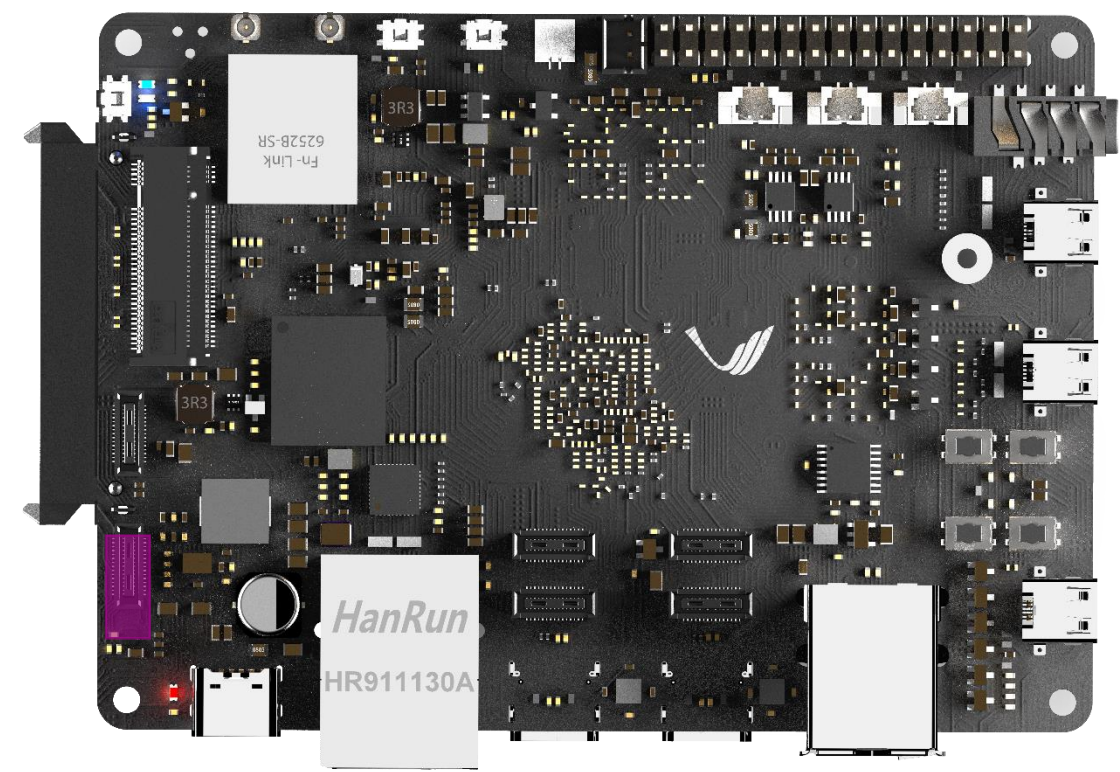



PWR
LED

Type-C Power Input
(12VDC-5A)

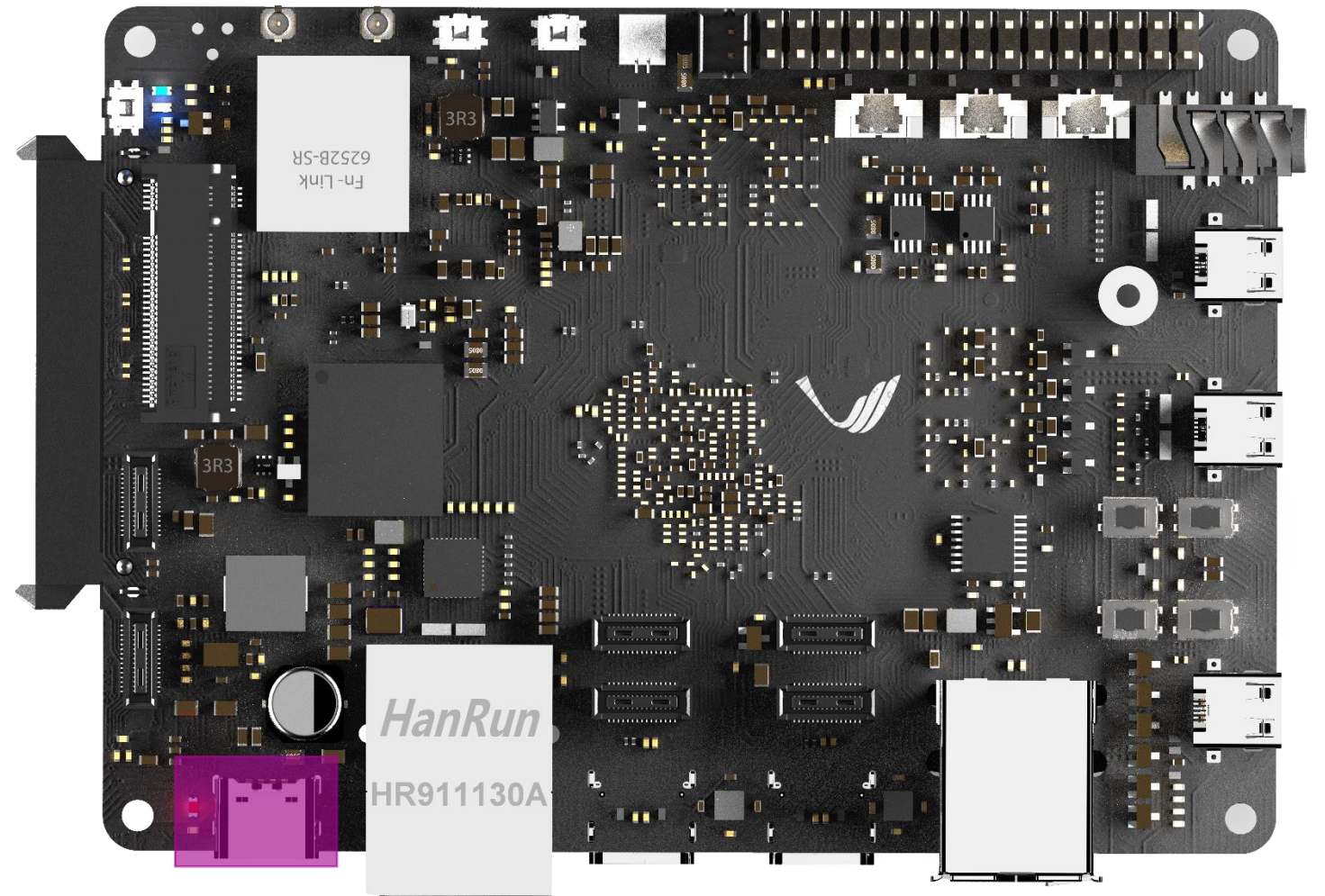

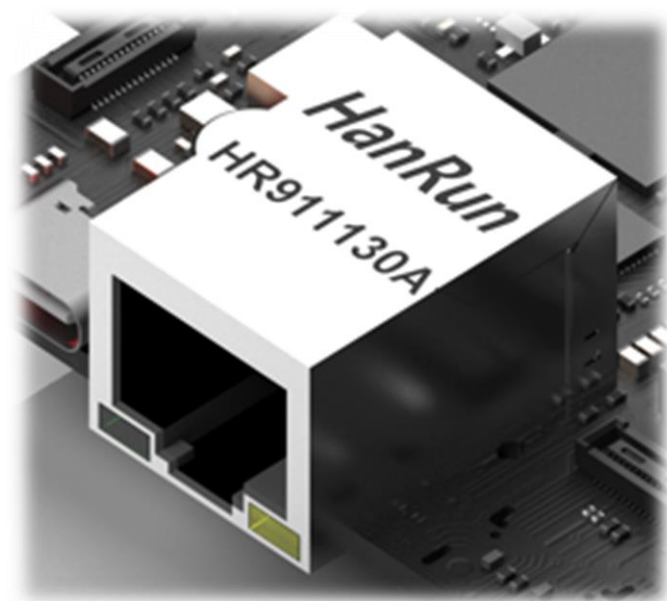

ETHERNET
(10/100/1000Mbps)

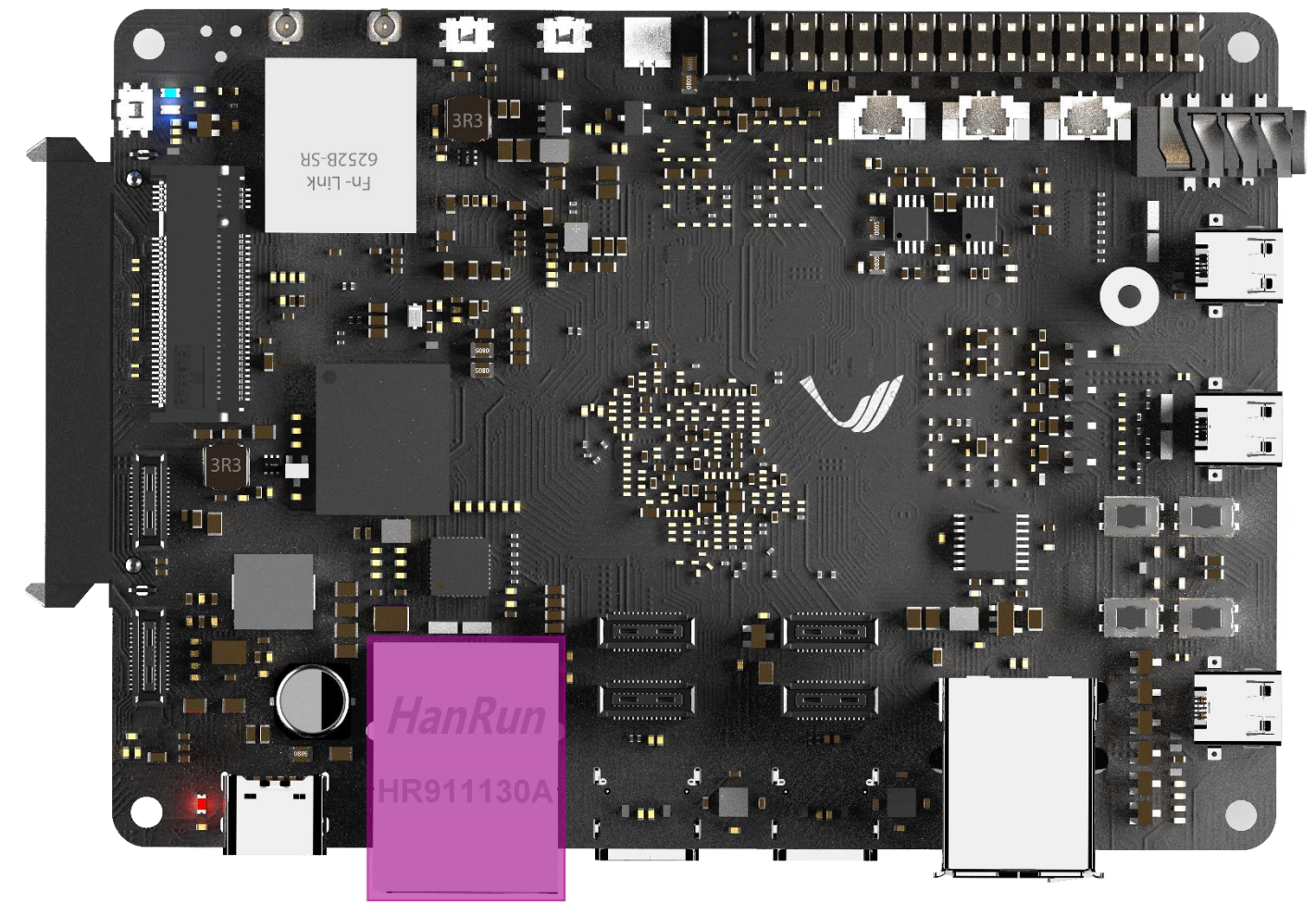

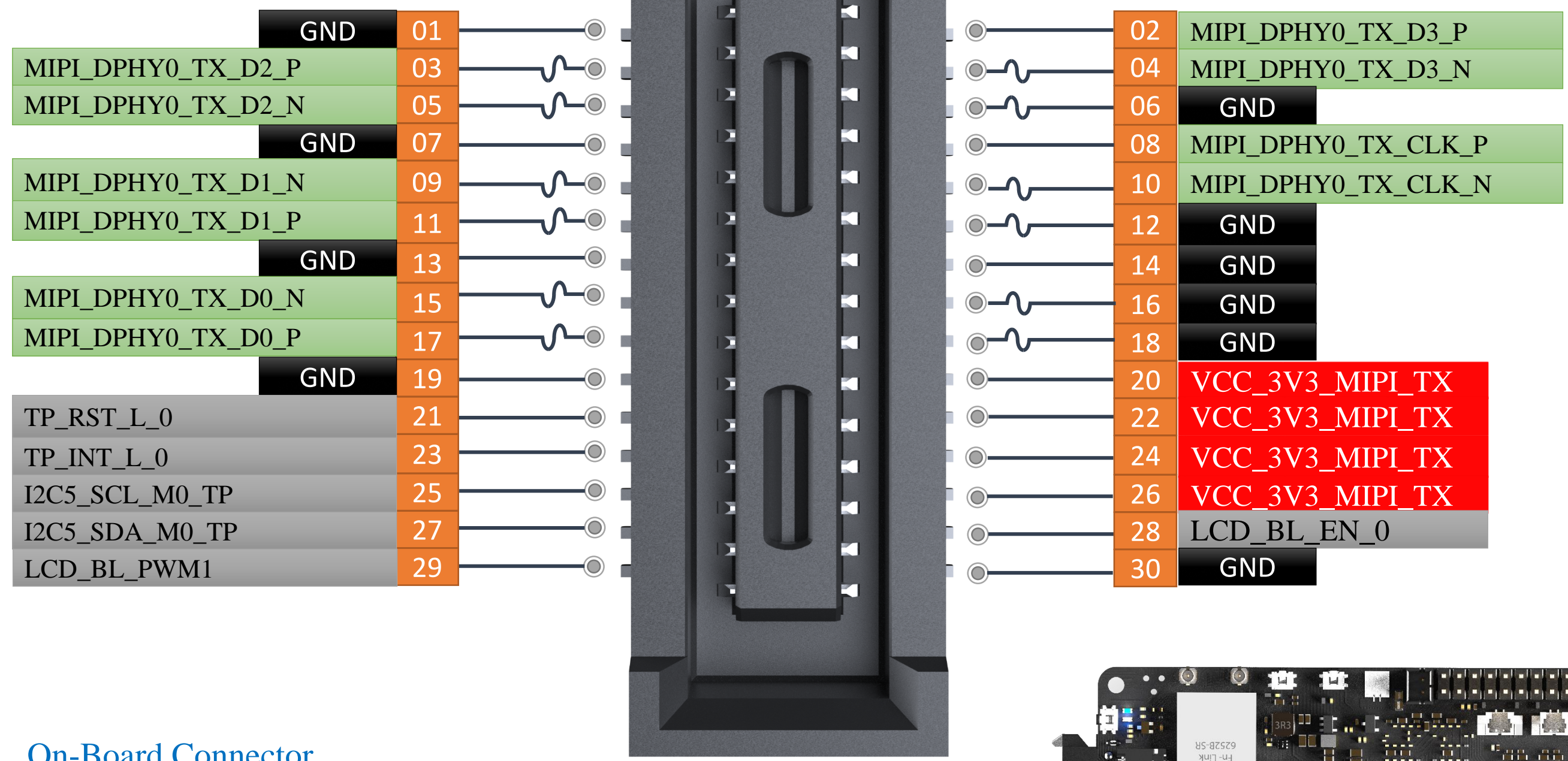

MIPI DPHY TX0

On-Board Connector

30 Pin
 0.4mm Pitch
 MPN : DF40HC(3.5)-30DS-0.4V(51)

Mating Connector

30 Pin
 0.4mm Pitch
 MPN : DF40C-30DP-0.4V(51)

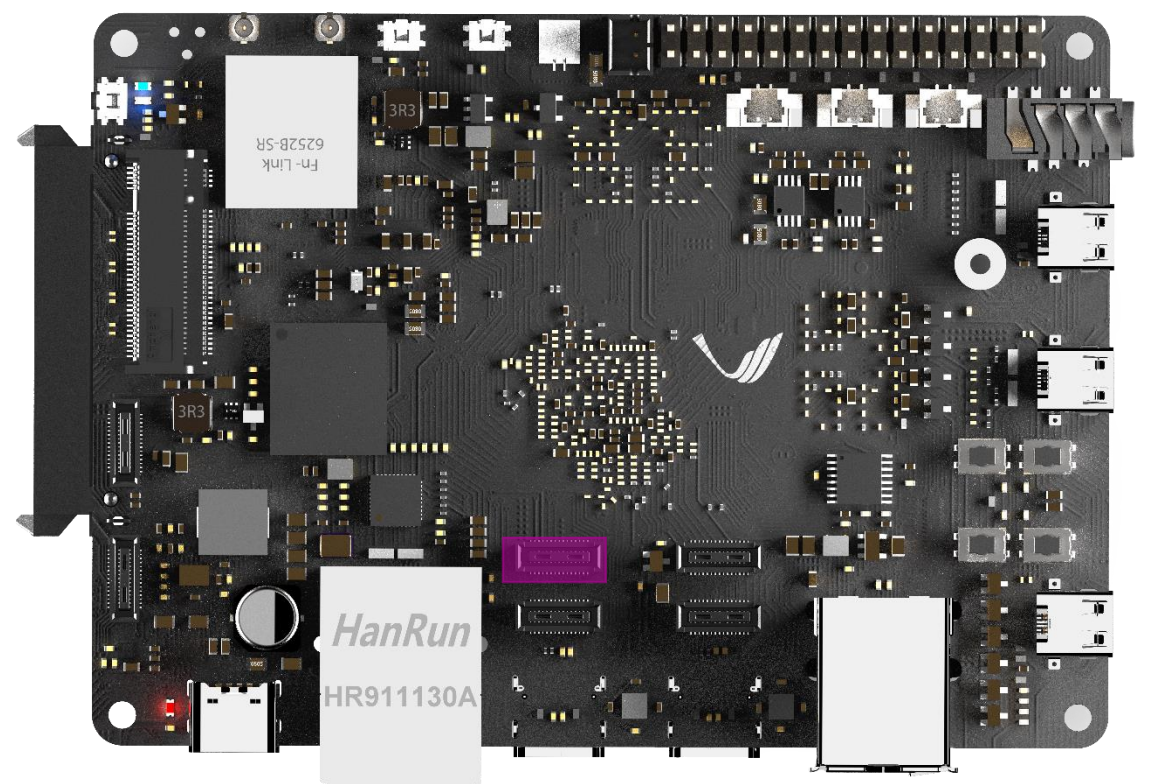

MIPI D-PHY TX PORT1

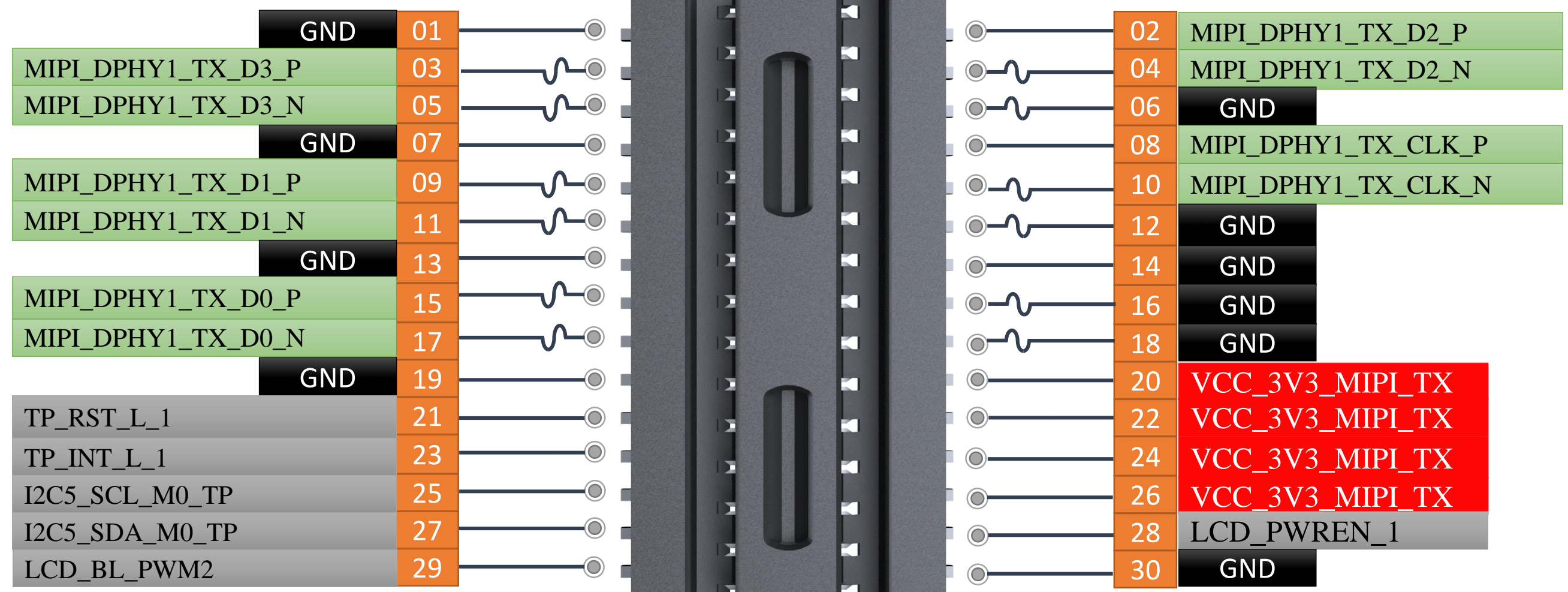

MIPI DPHY TX1

On-Board Connector
 30 Pin
 0.4mm Pitch
 MPN : DF40HB(2.0)-30DS-0.4V(51)

Mating Connector
 30 Pin
 0.4mm Pitch
 MPN : DF40C-30DP-0.4V(51)

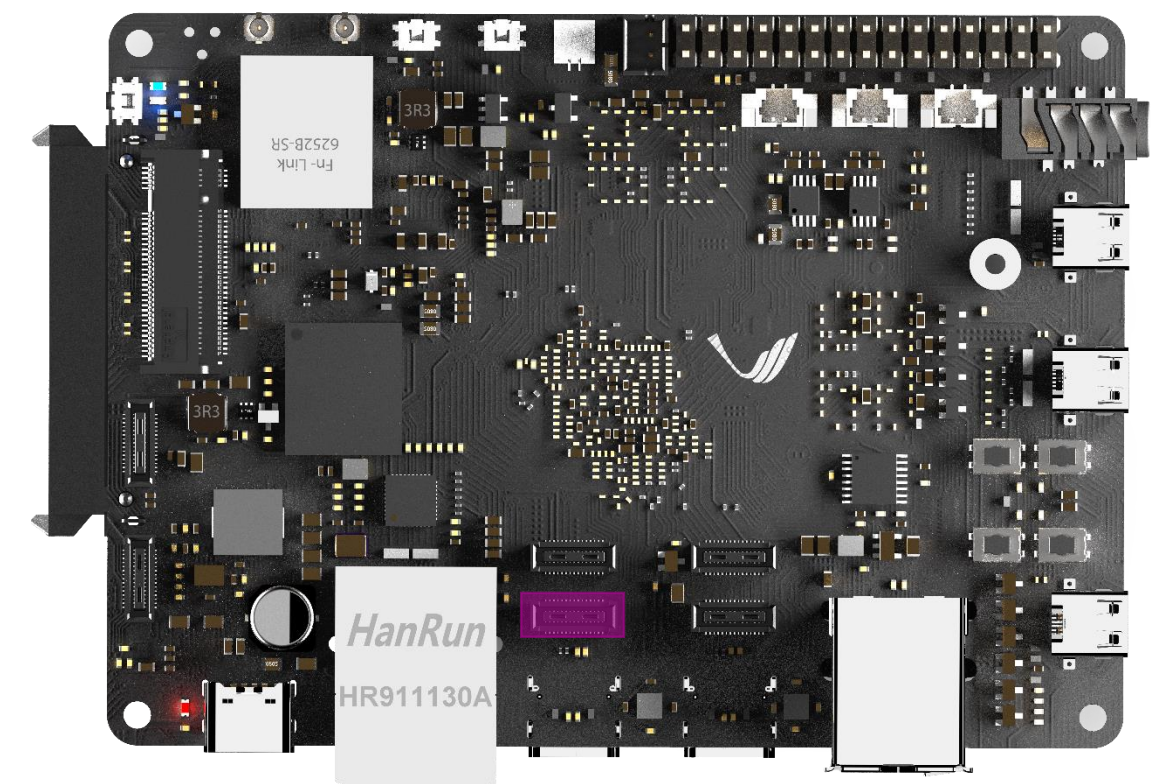

	GND	01
MIPI_DPHY0_RX_D3_P		03
MIPI_DPHY0_RX_D3_N		05
	GND	07
MIPI_DPHY0_RX_D1_P		09
MIPI_DPHY0_RX_D1_N		11
	GND	13
MIPI_DPHY0_RX_D0_P		15
MIPI_DPHY0_RX_D0_N		17
	GND	19
MIPI_CAM2_CLKOUT		21
MIPI_CAM1/2_RESET_L		23
MIPI_CAM2_PDN_L		25
I2C2_SCL_M4_MIPI		27
I2C2_SDA_M4_MIPI		29

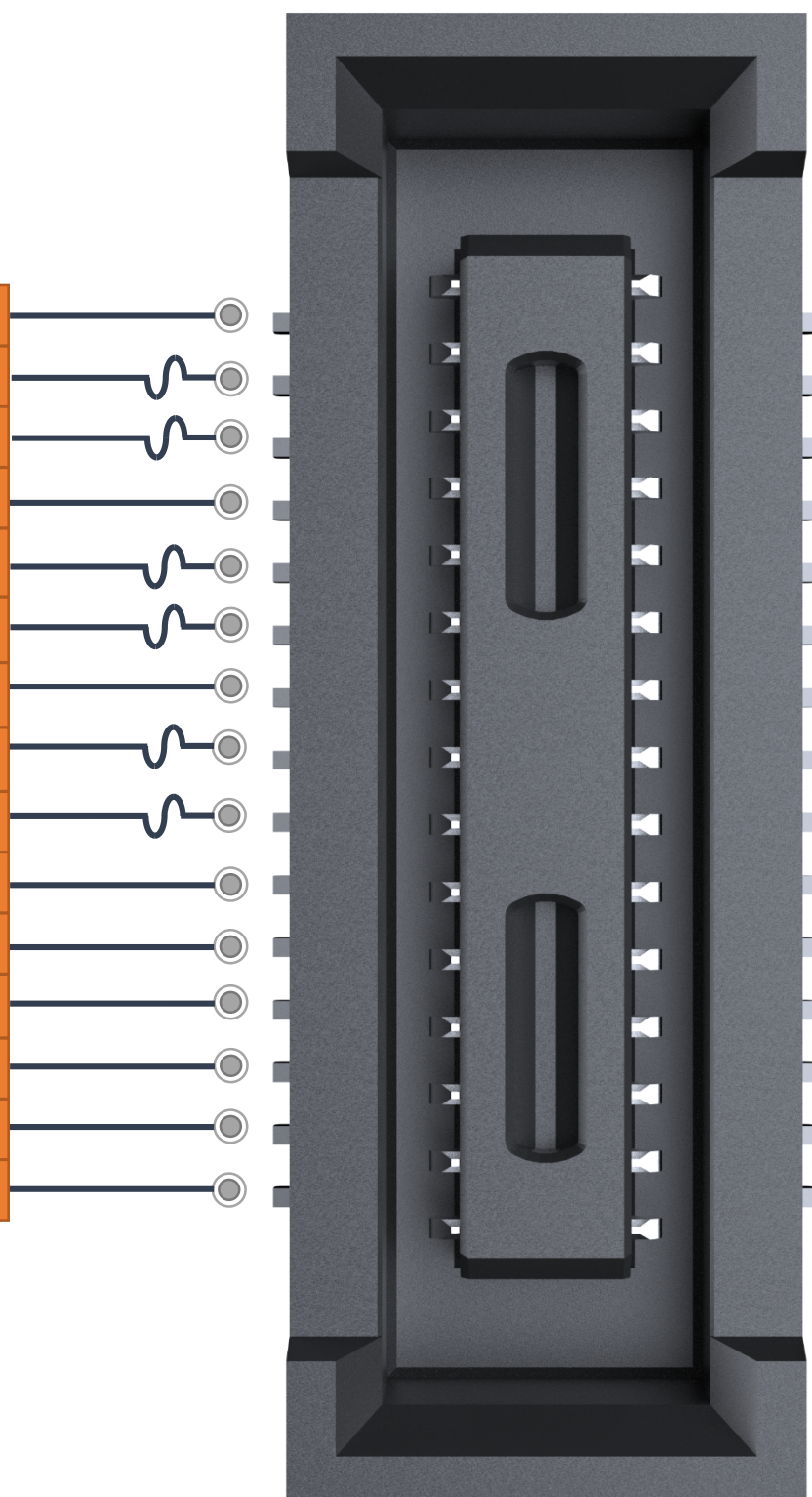

02	MIPI_DPHY0_RX_D2_P
04	MIPI_DPHY0_RX_D2_N
06	GND
08	MIPI_DPHY0_RX_CLK_P
10	MIPI_DPHY0_RX_CLK_N
12	GND
14	GND
16	GND
18	GND
20	VCC_3V3_MIPI_TX
22	VCC_3V3_MIPI_TX
24	VCC_3V3_MIPI_TX
26	VCC_3V3_MIPI_TX
28	GND
30	GND

On-Board Connector

30 Pin
 0.4mm Pitch
 MPN : DF40HB(2.0)-30DS-0.4V(51)

Mating Connector

30 Pin
 0.4mm Pitch
 MPN : DF40C-30DP-0.4V(51)

MIPI DPHY RX0

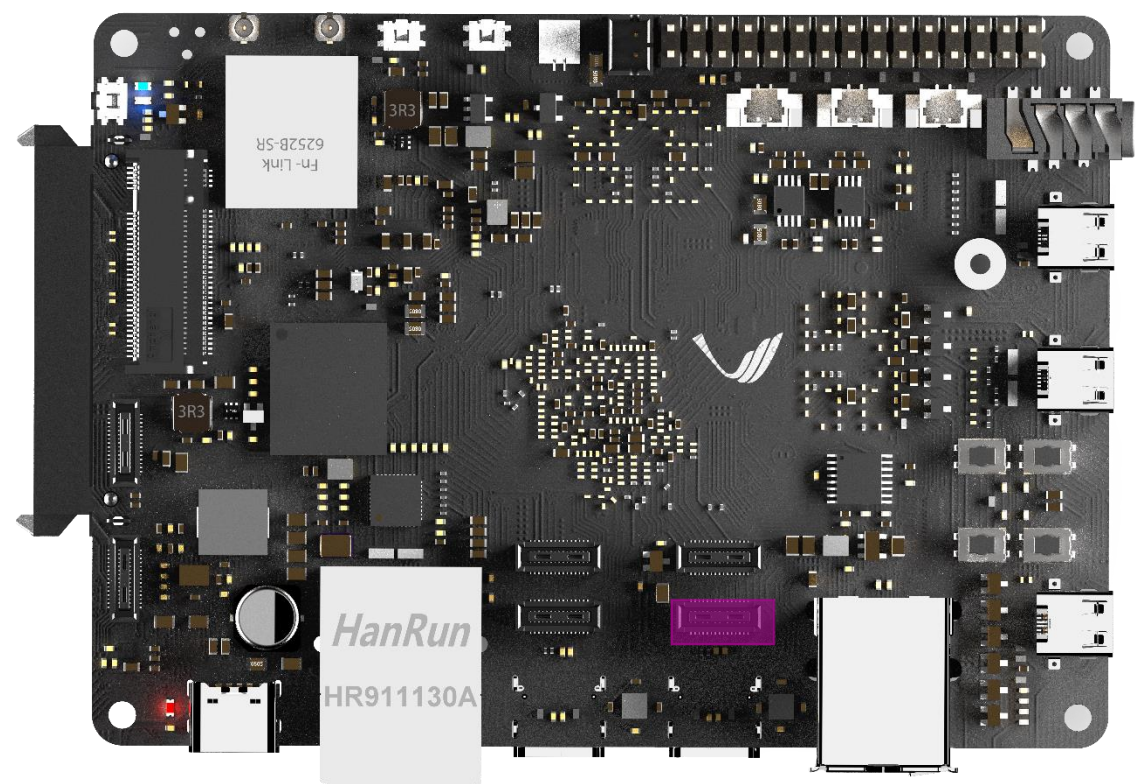

MIPI D-PHY RX PORT1

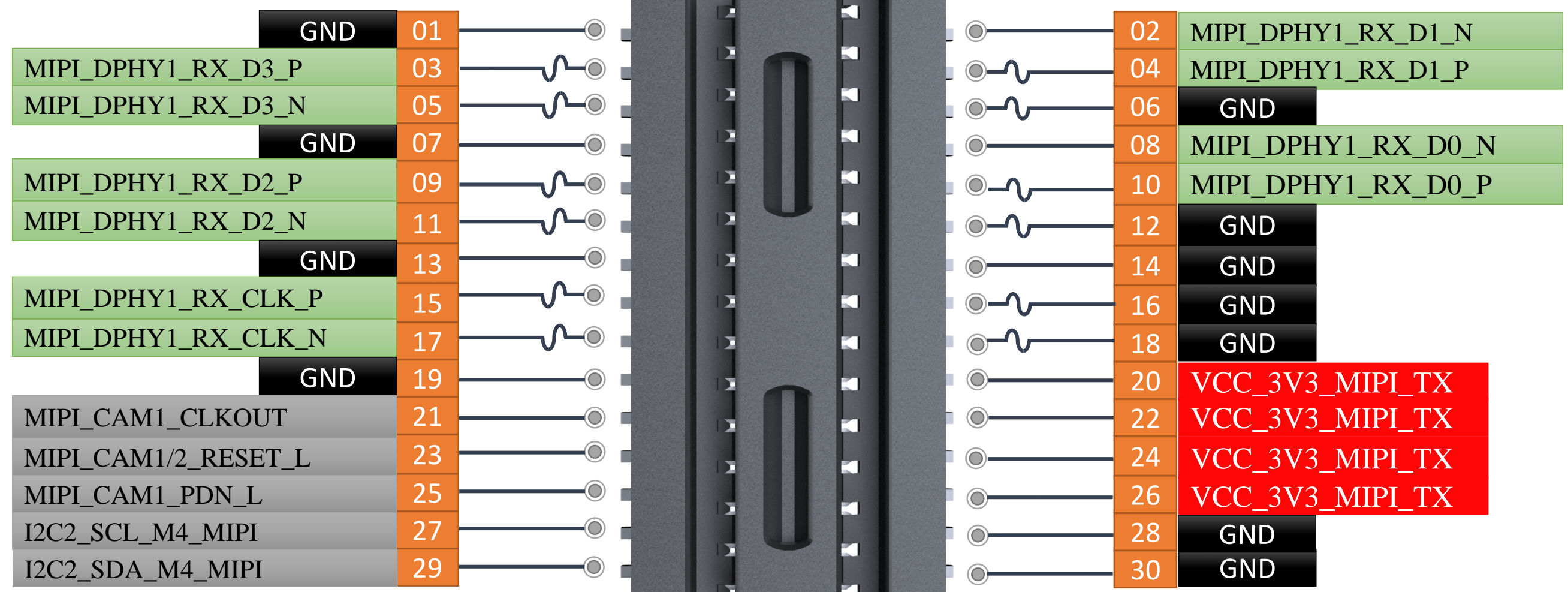

MIPI DPHY RX1

On-Board Connector
 30 Pin
 0.4mm Pitch
 MPN : DF40HC(3.5)-30DS-0.4V(51)

Mating Connector
 30 Pin
 0.4mm Pitch
 MPN : DF40C-30DP-0.4V(51)

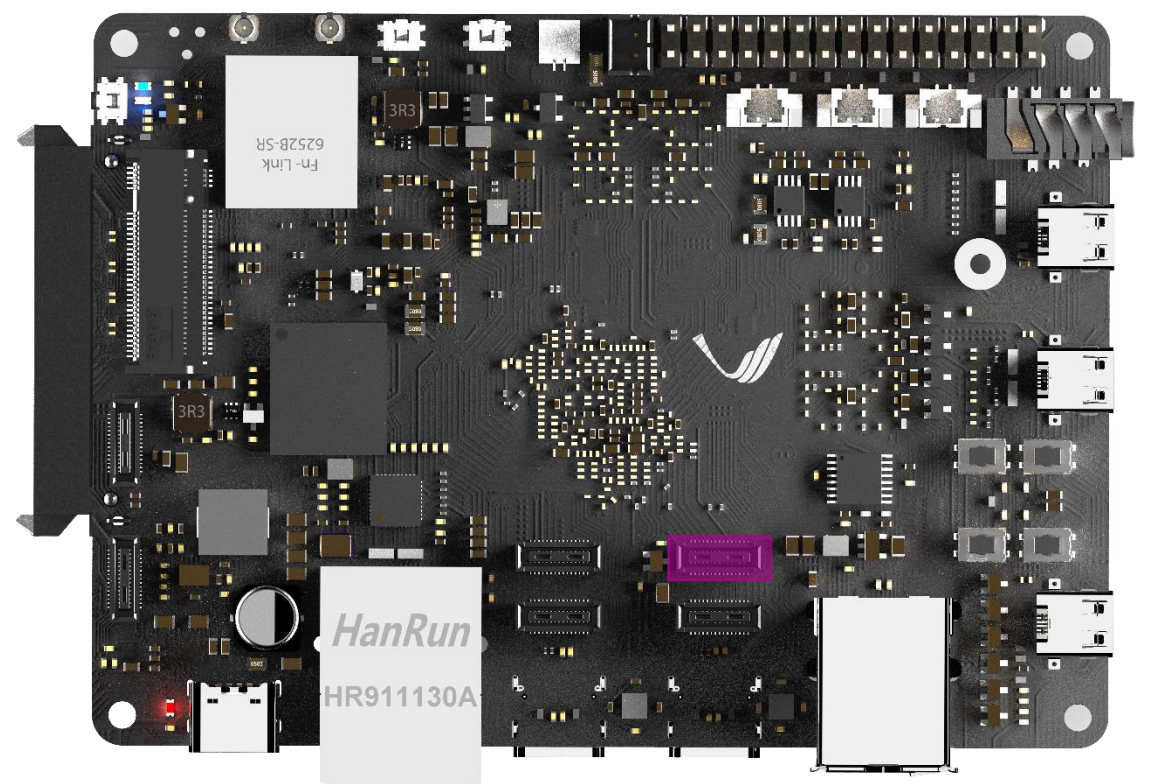

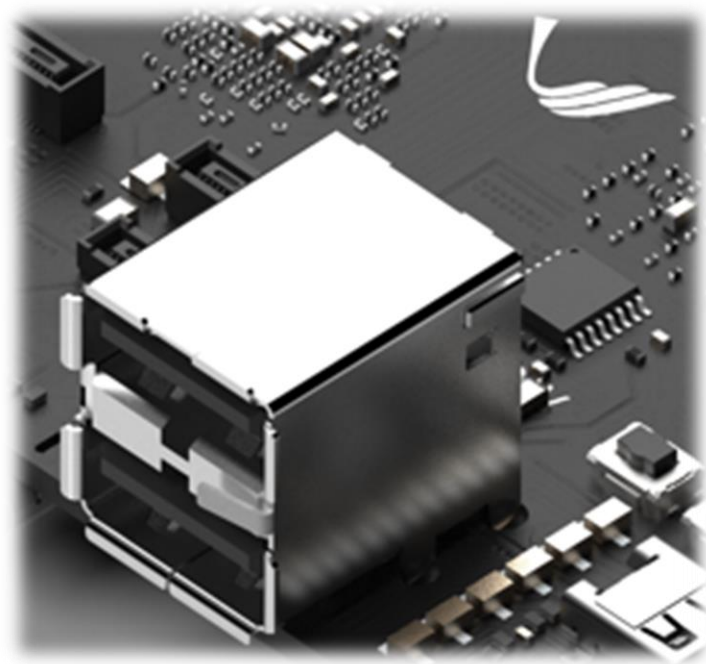

2x USB2.0 HOST

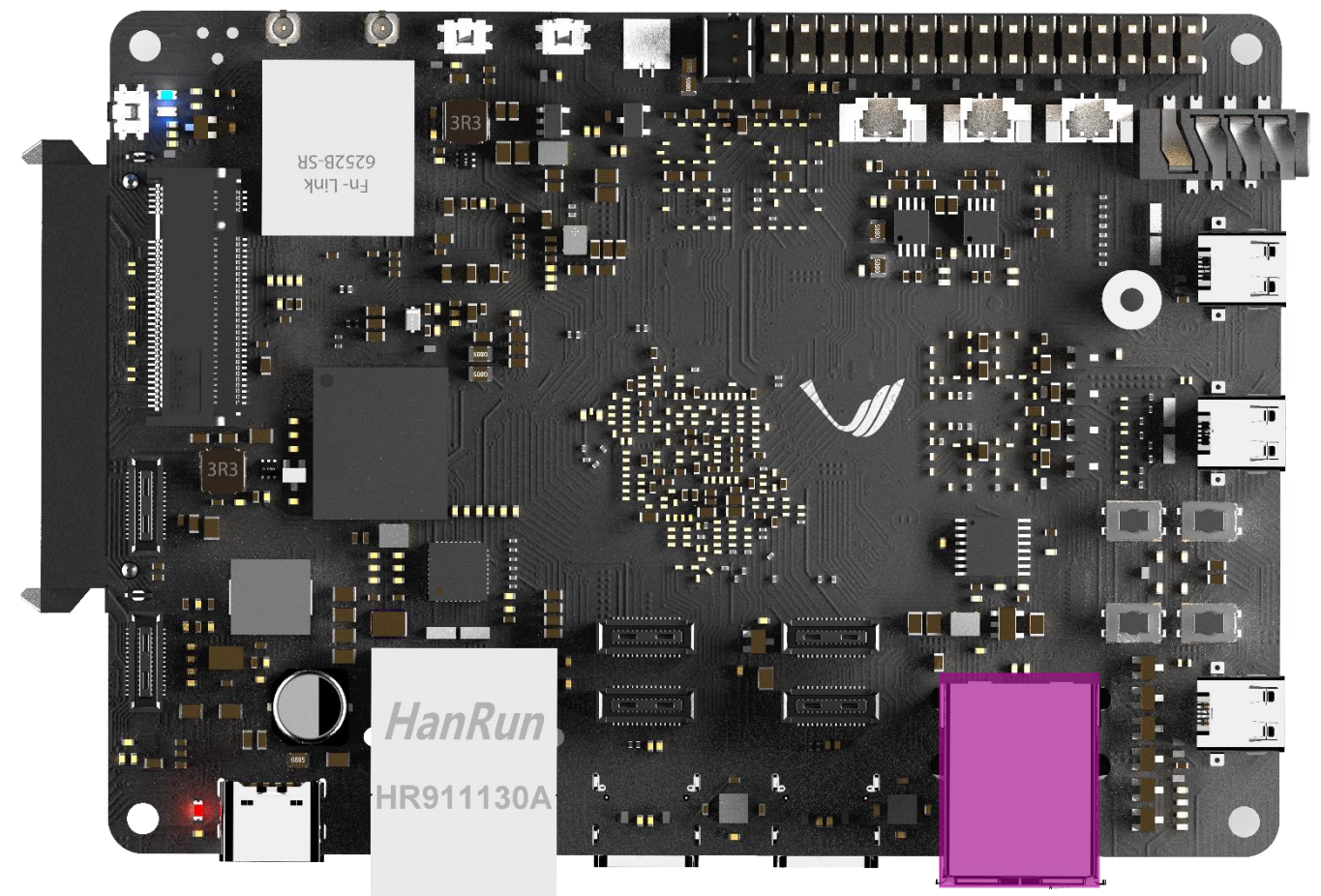

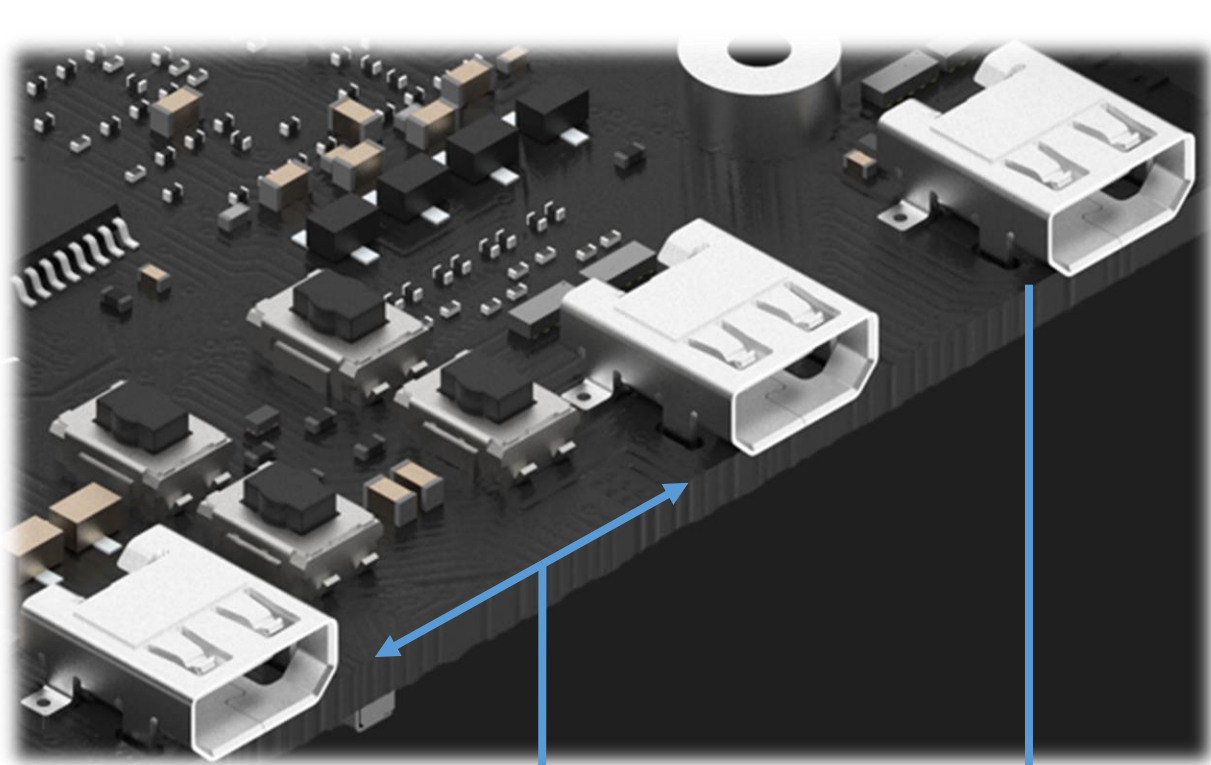

2x HDMI TX

HDMI RX

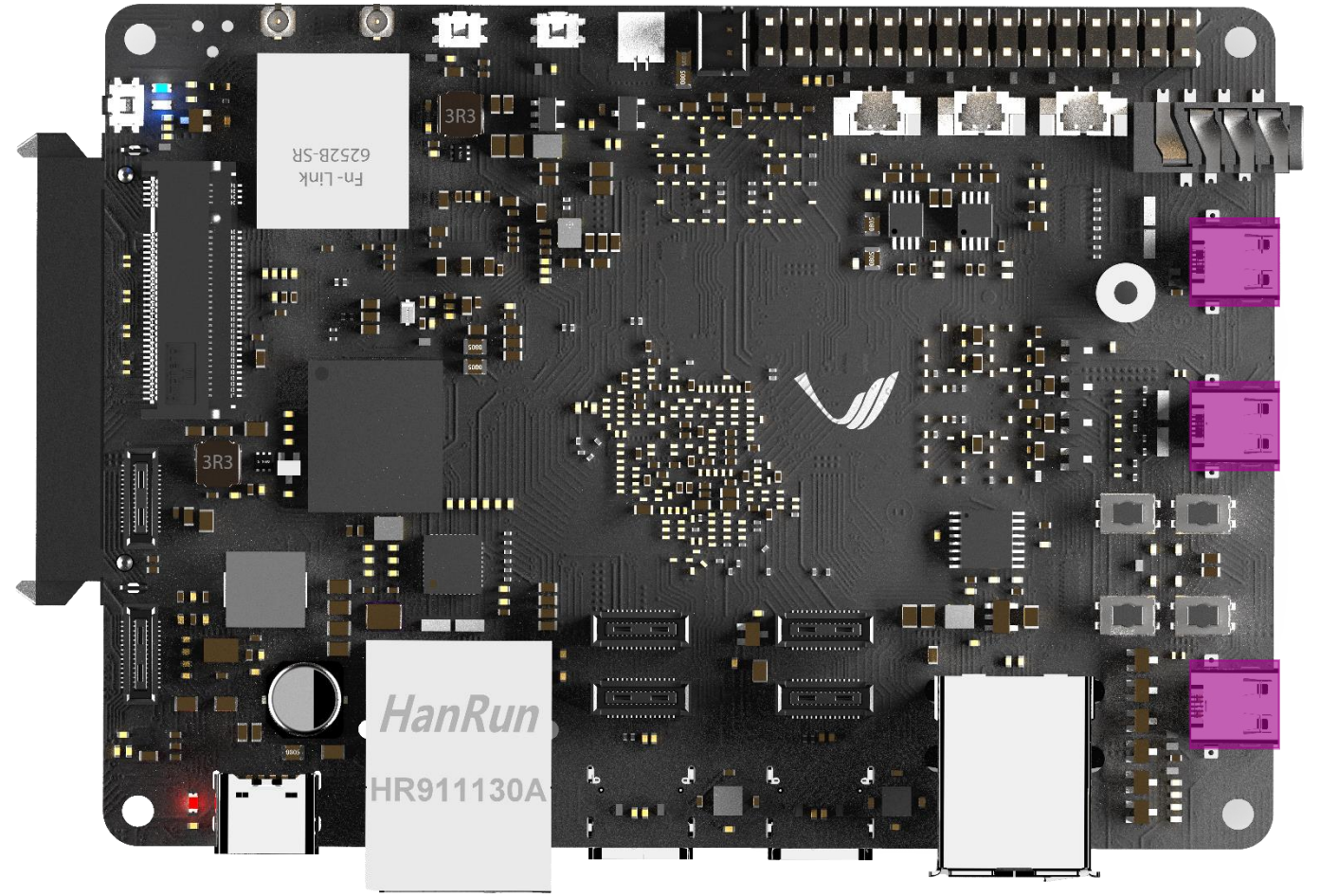

HanRun
HR911130A

Fn-Link
6252B-SR

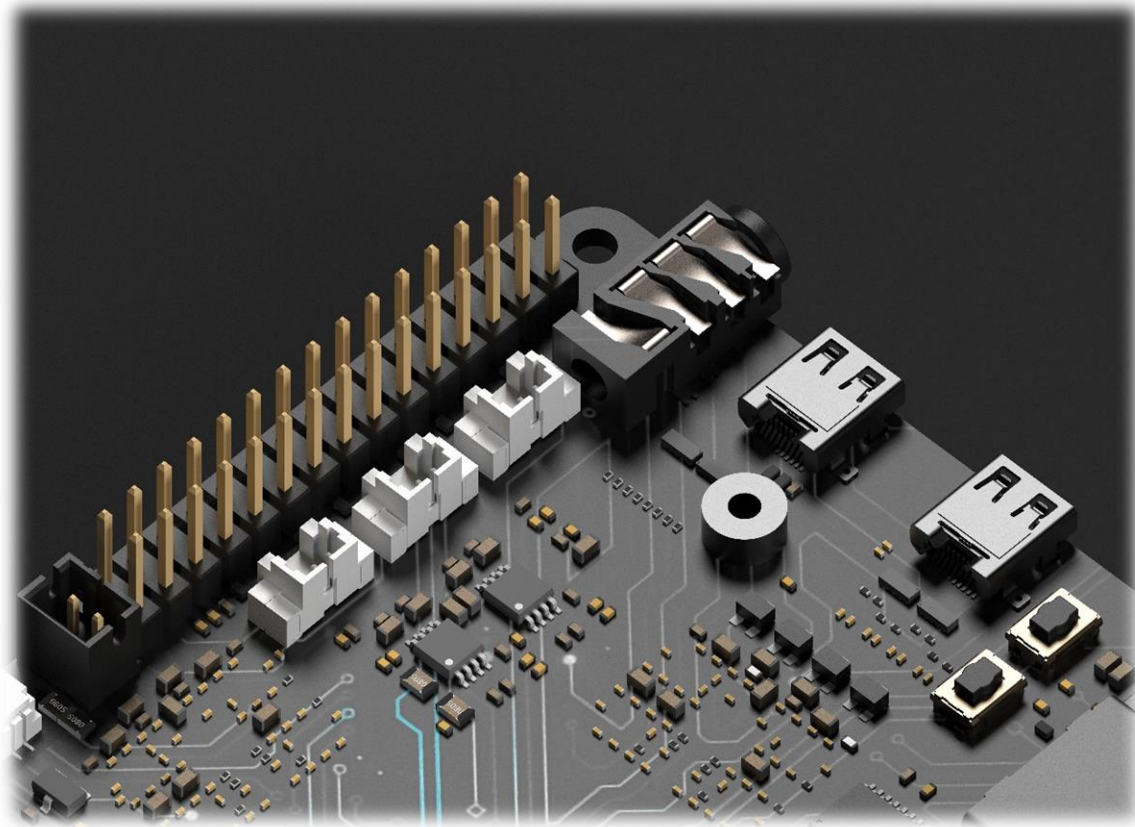

3.5mm Audio Jack with MIC

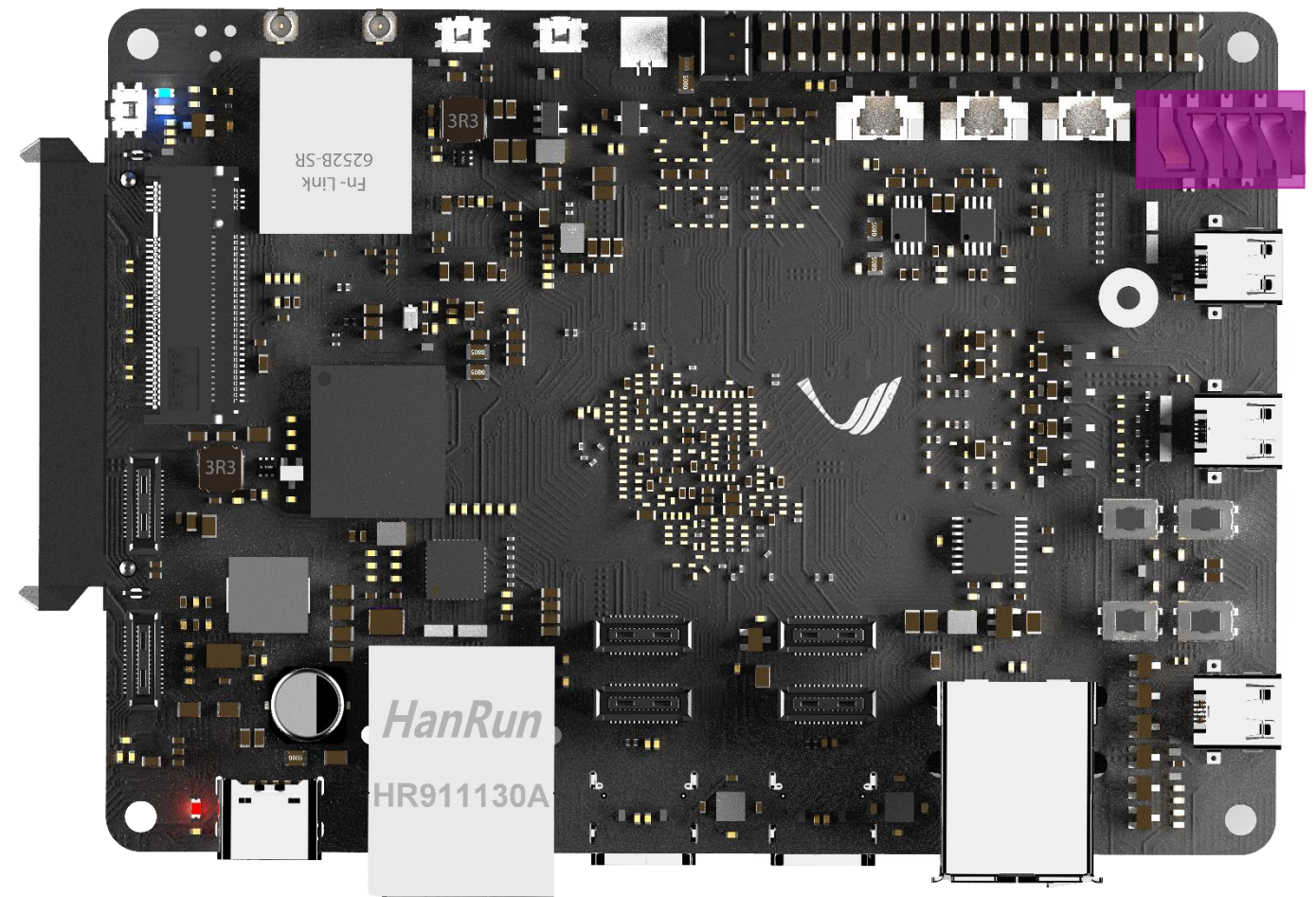

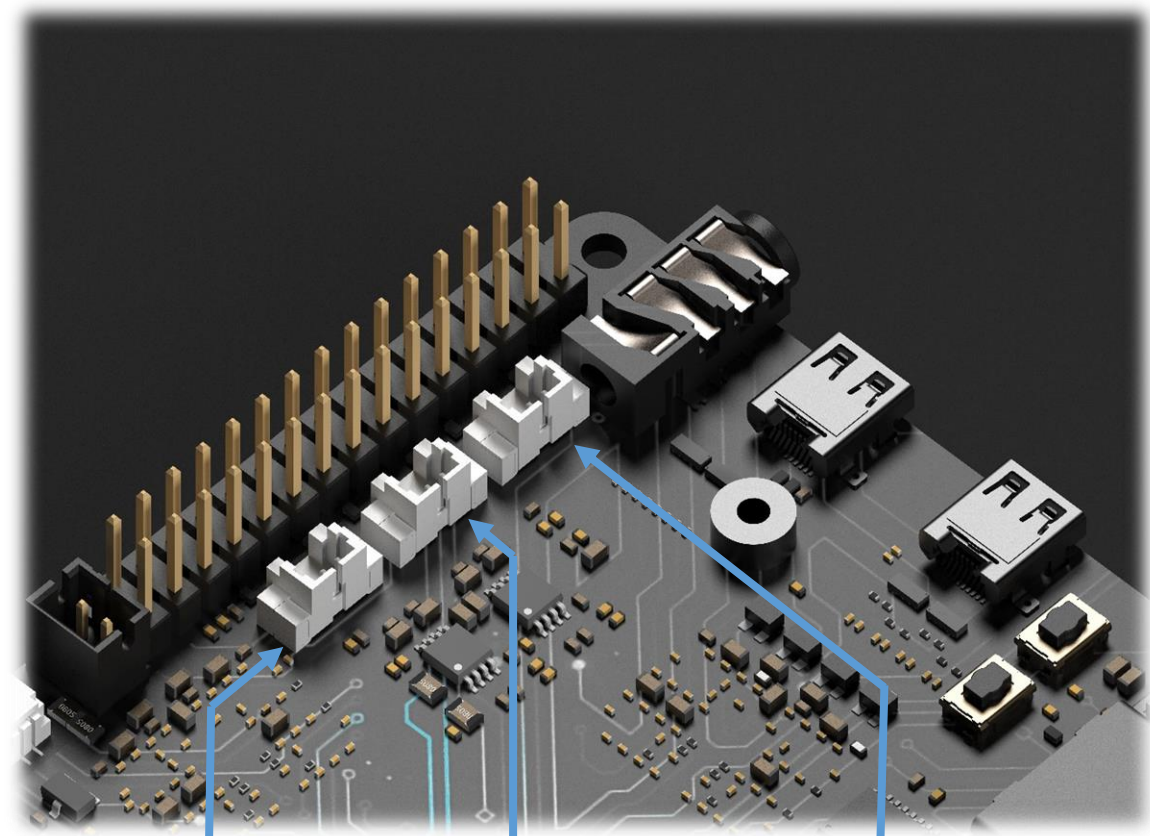

SPK_L

SPK_R

Analog MIC

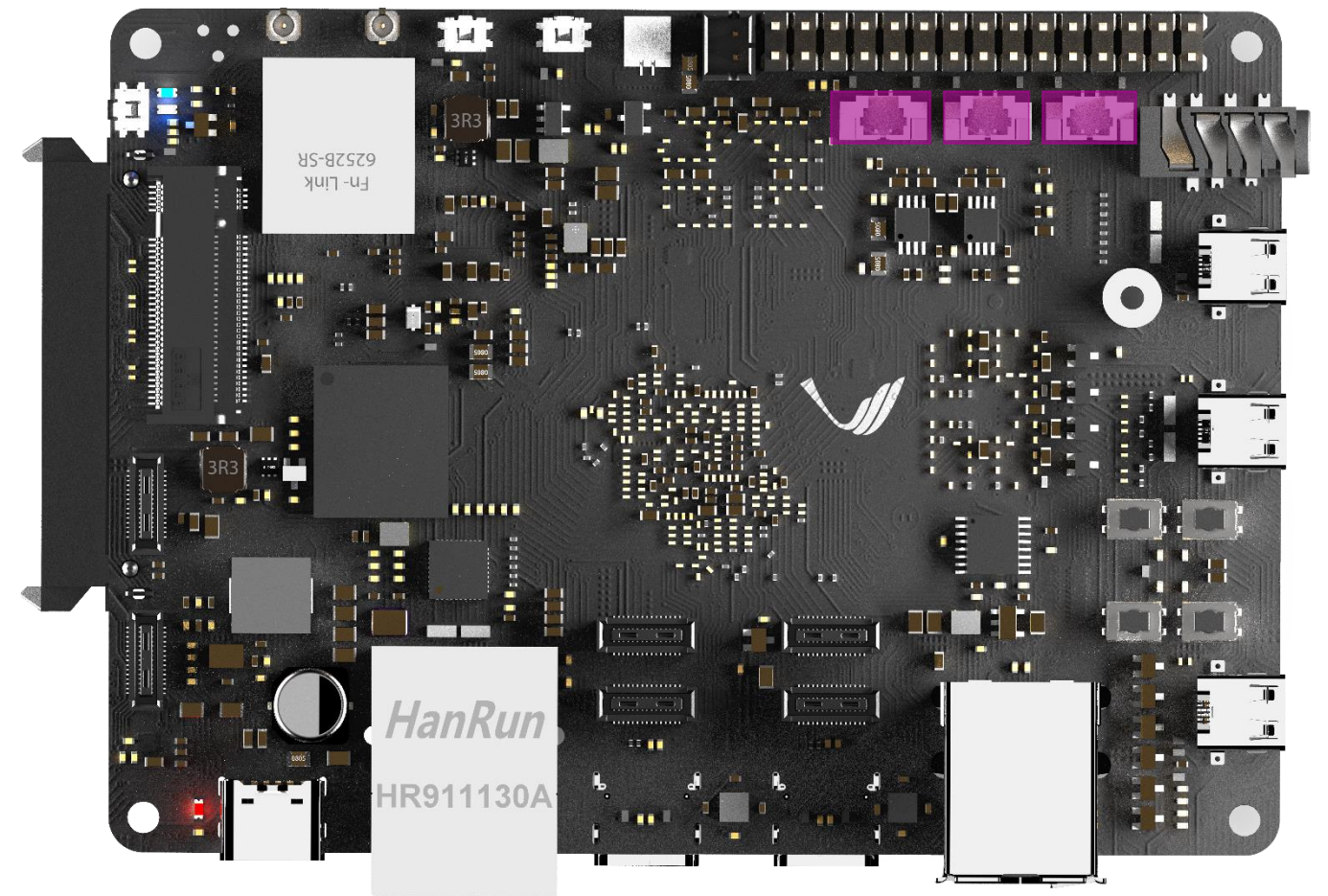

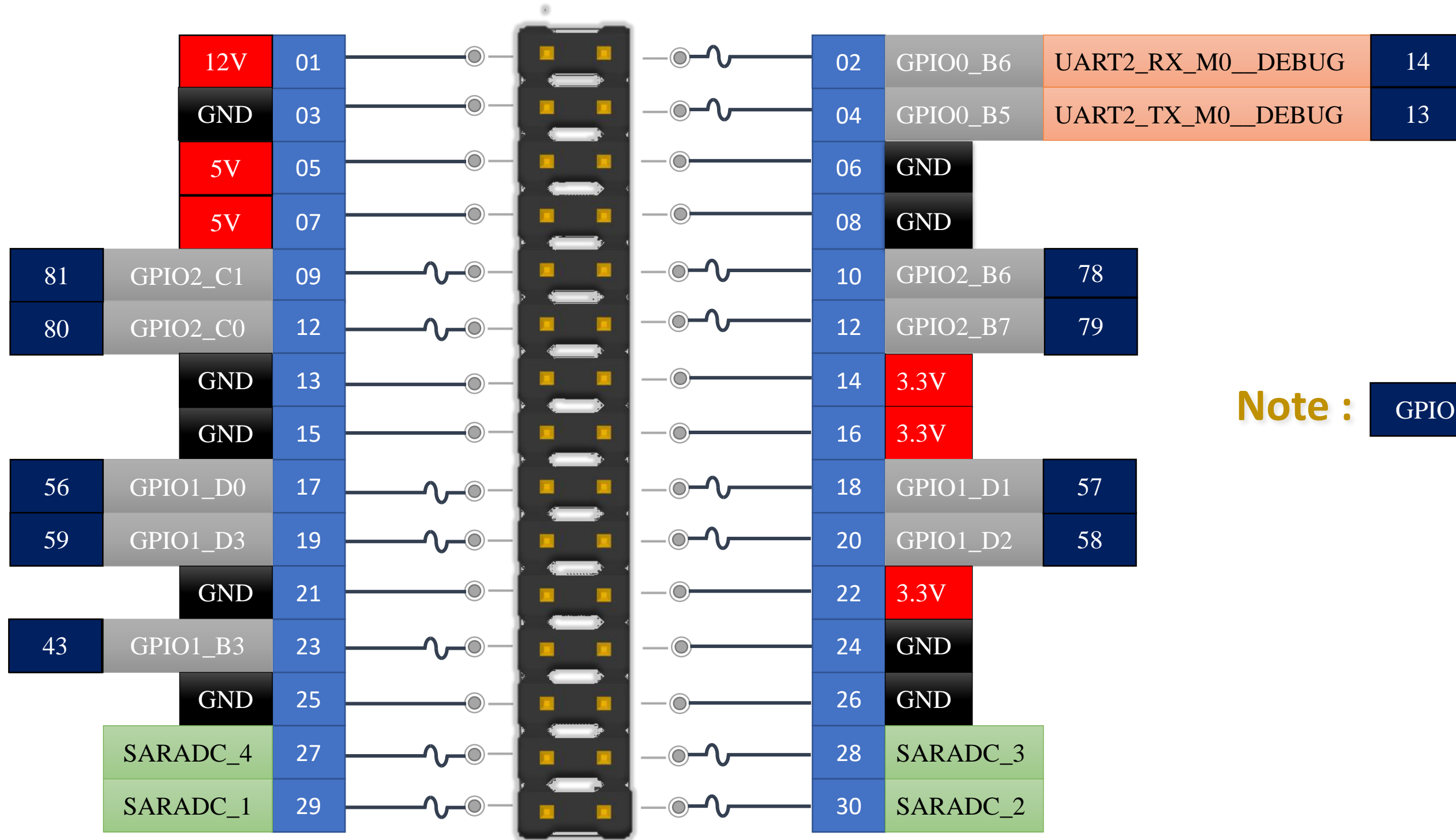

Note : GPIO Pin Number

RK3588 30Pin GPIO Header 2.54mm

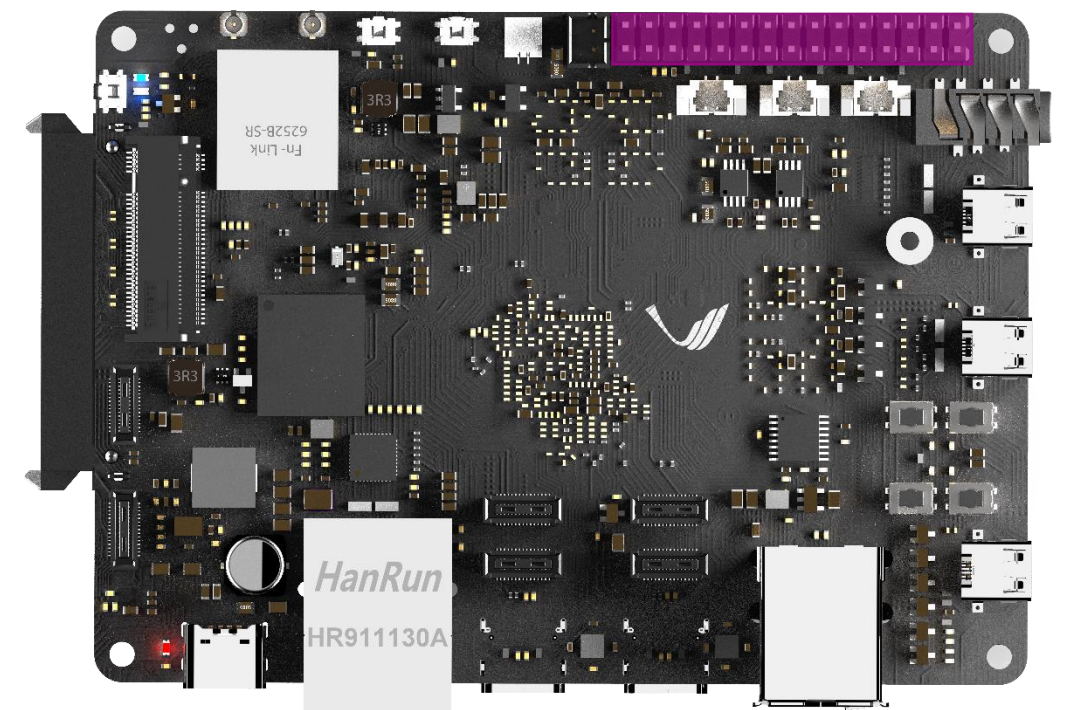

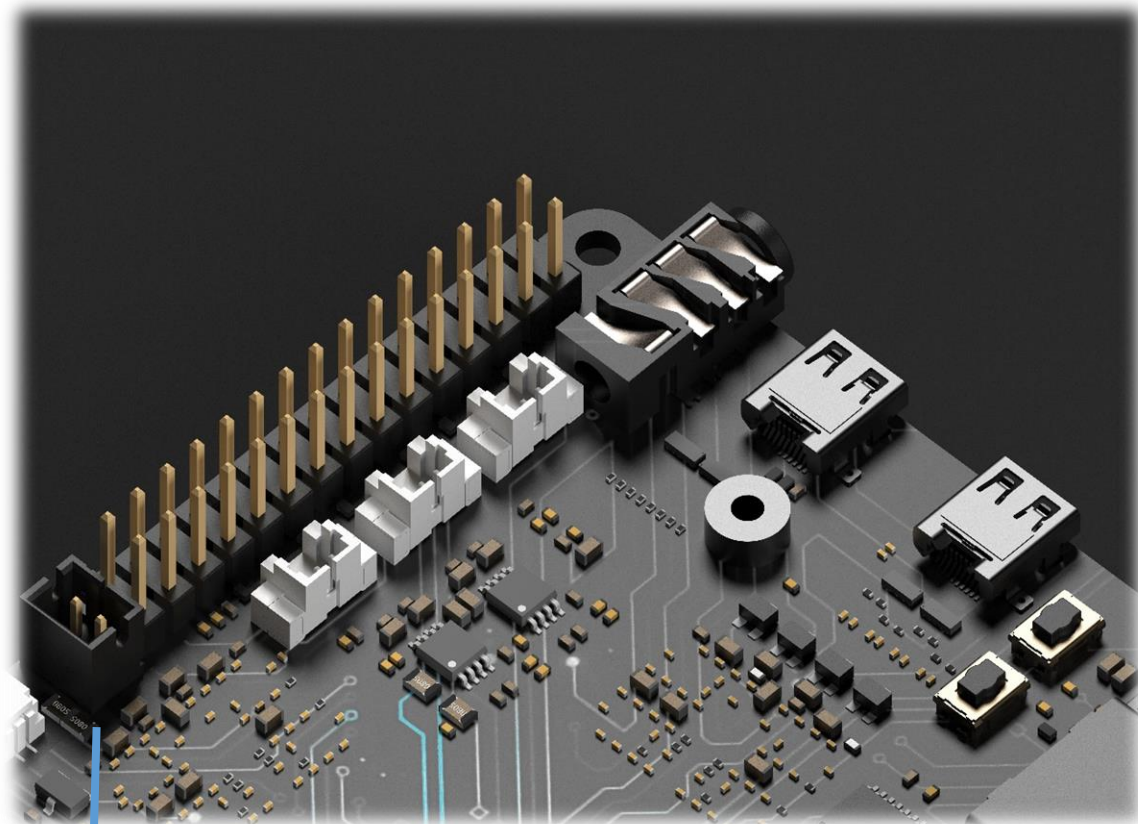

Fan Connector : 2.0mm Pitch

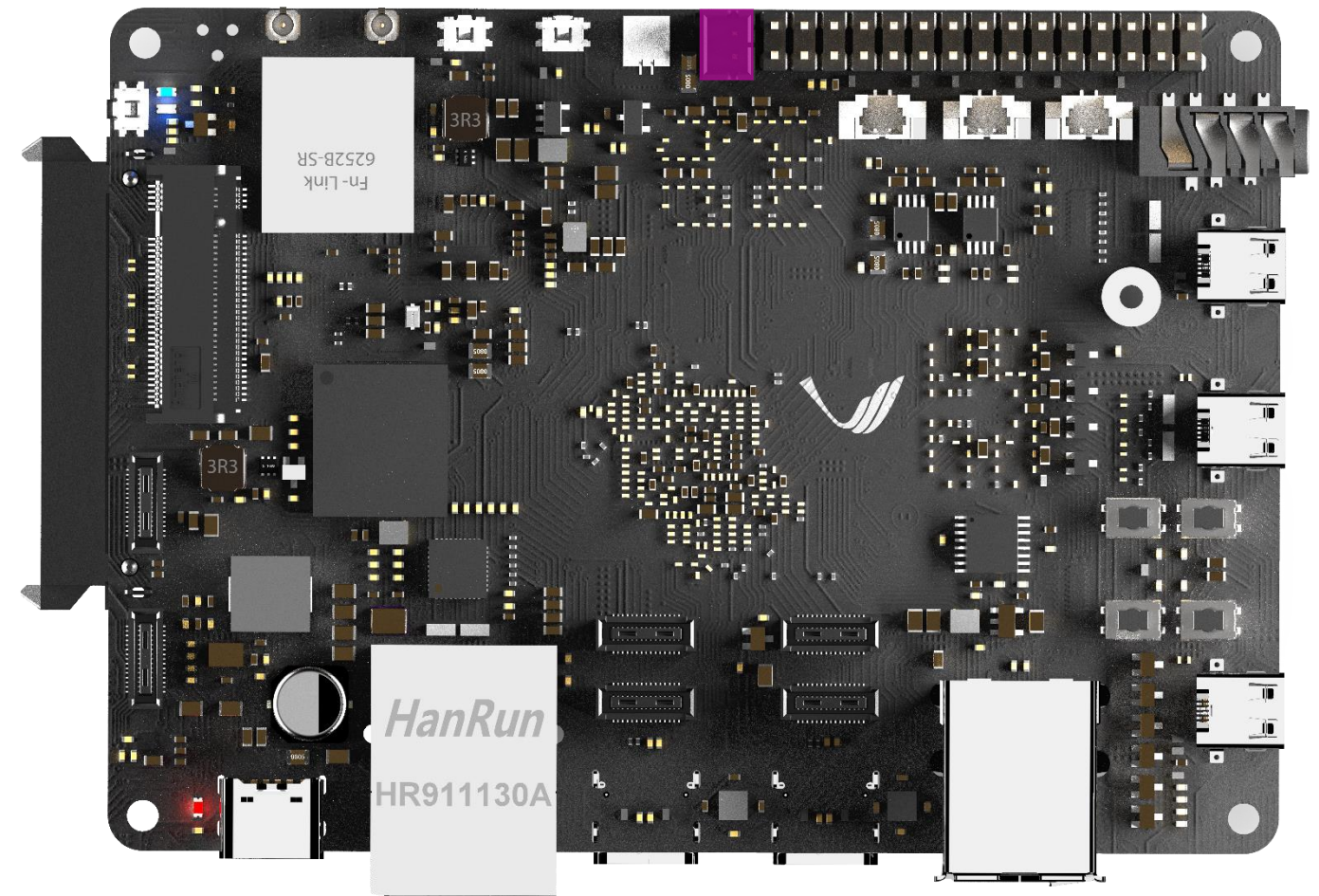

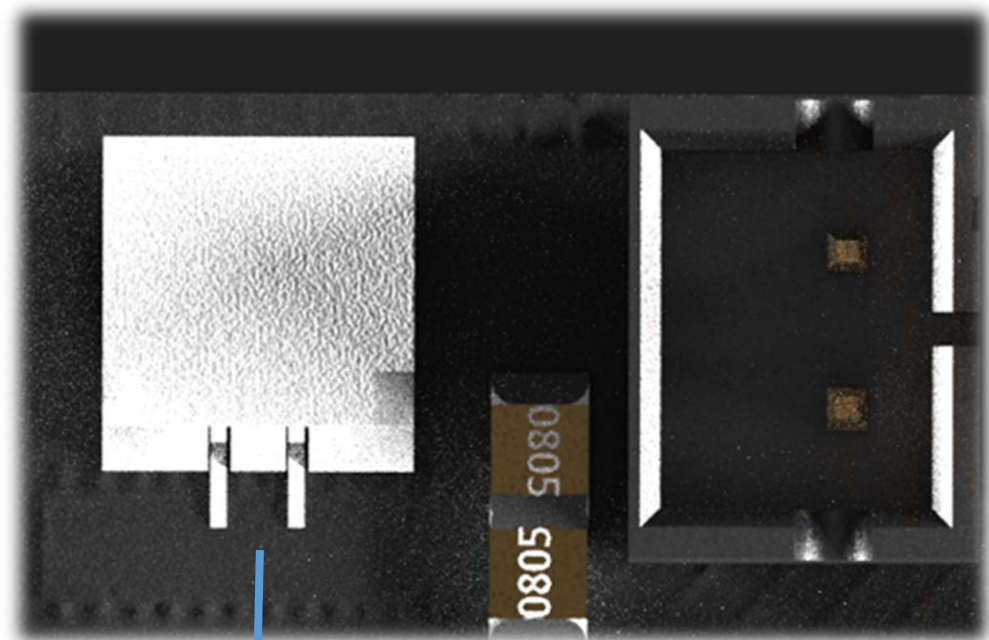

RTC Battery Connector

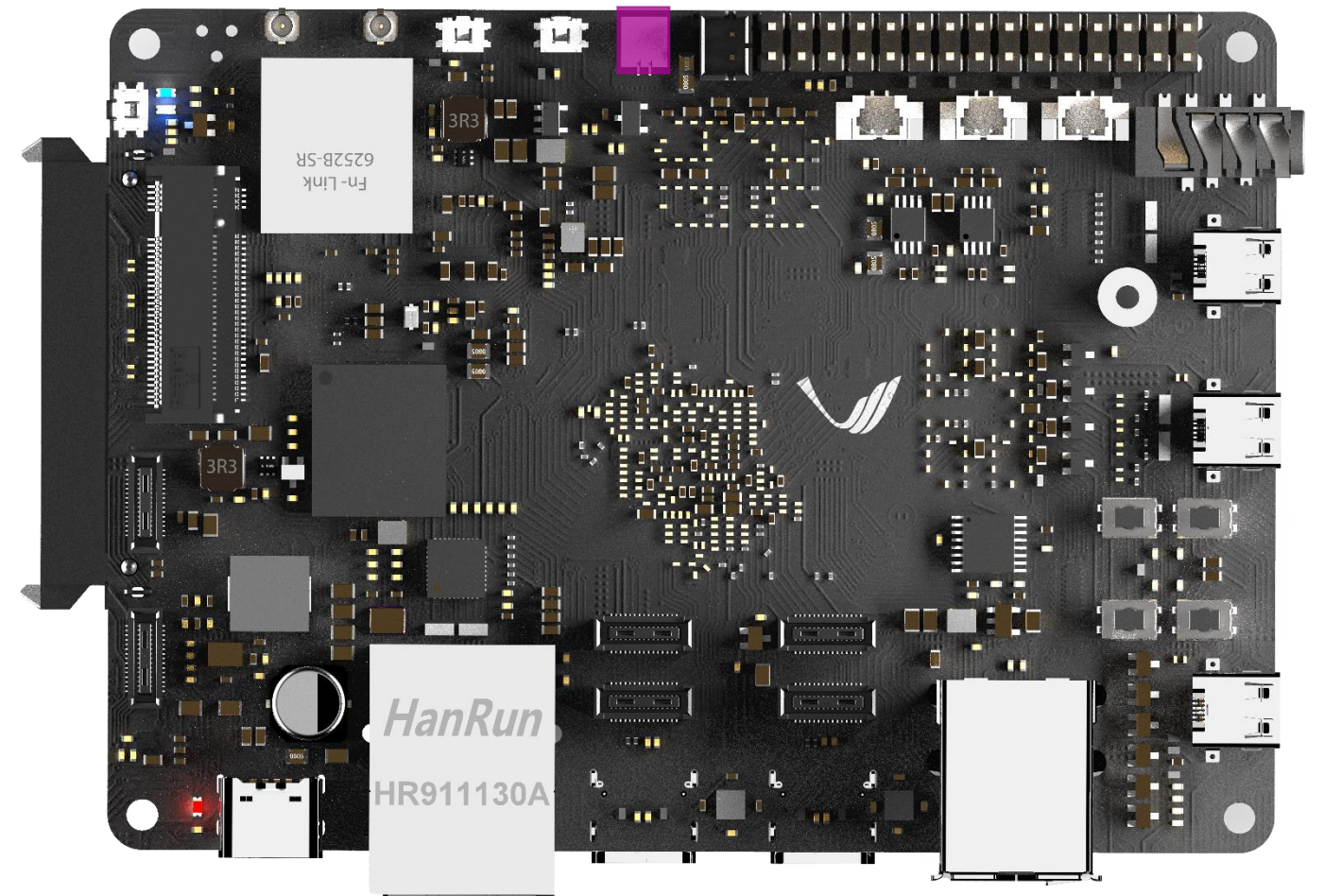

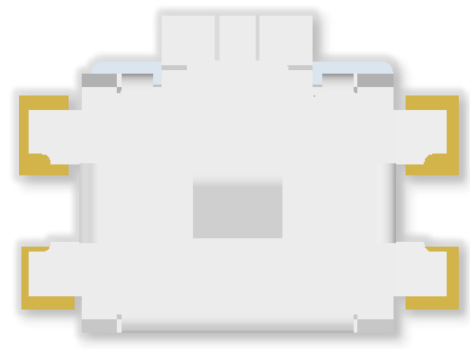

**PWR
on/off
Key**

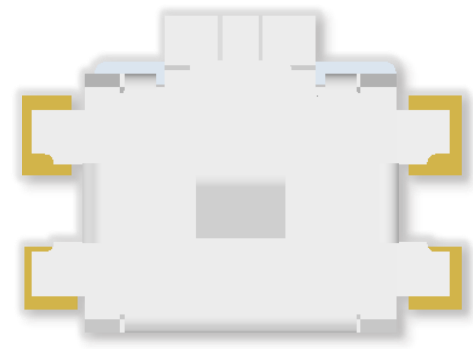

**Reset
Key**

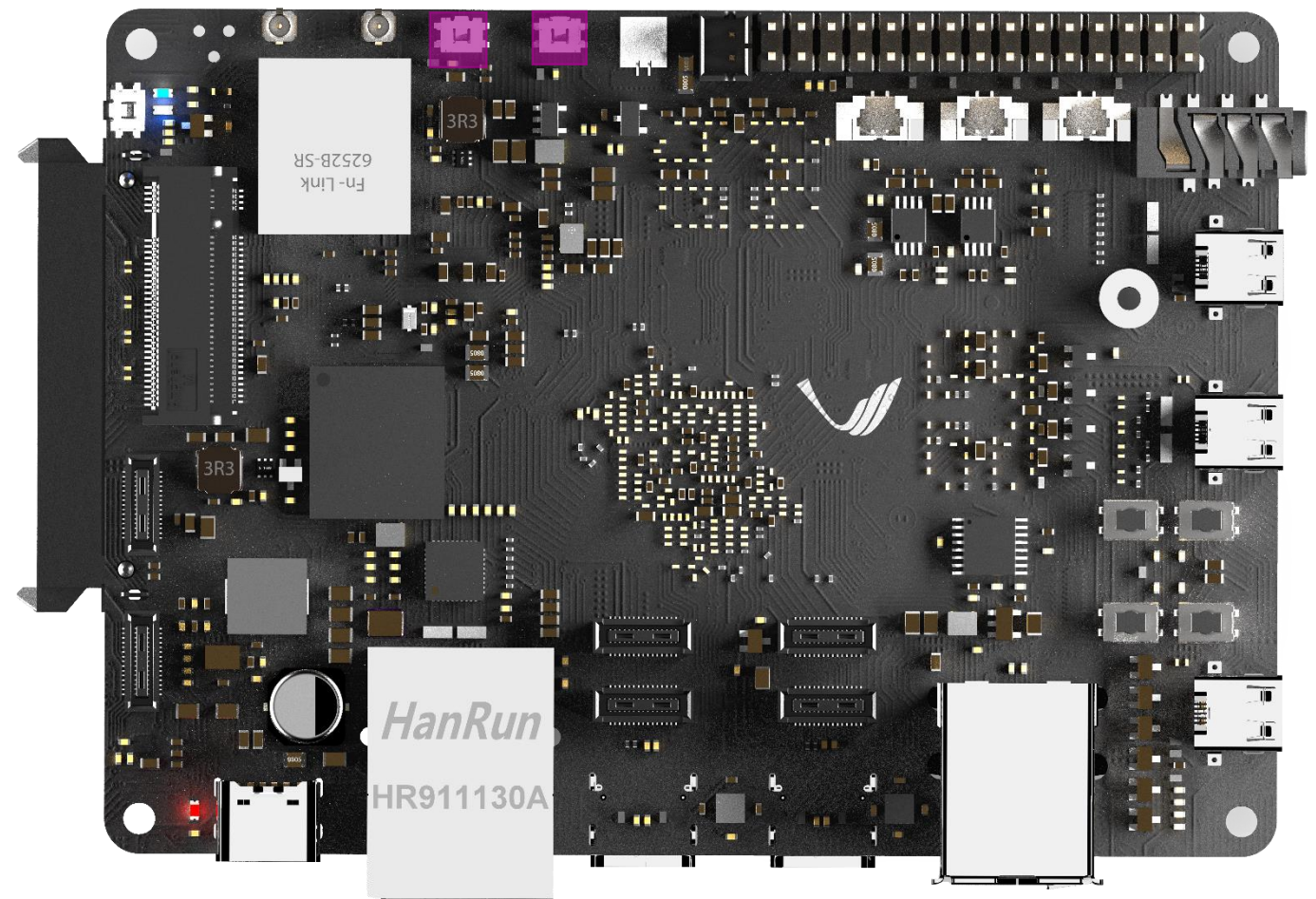

WIFI WIFI/BT

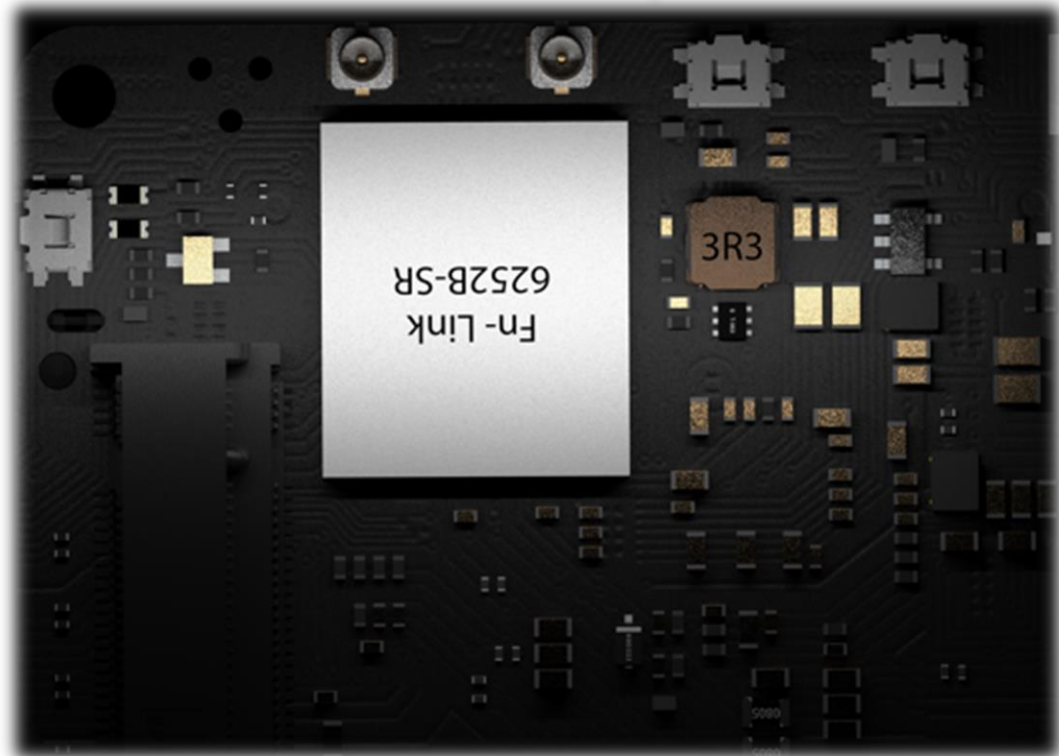

6252B-SR Wifi6 BT5.2 Module

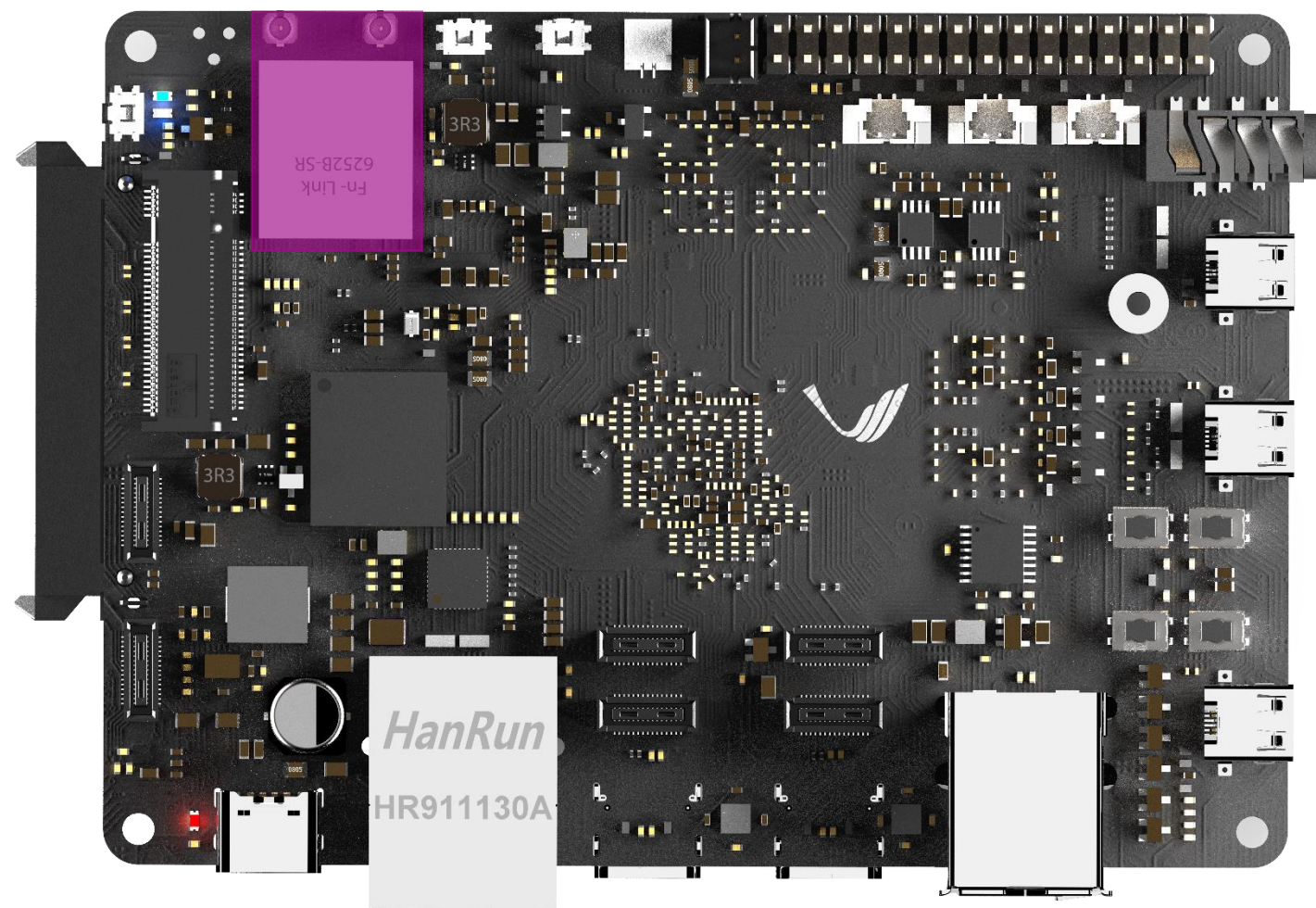

21 PCIe GEN/SATA3.0 FPC CONNECTOR

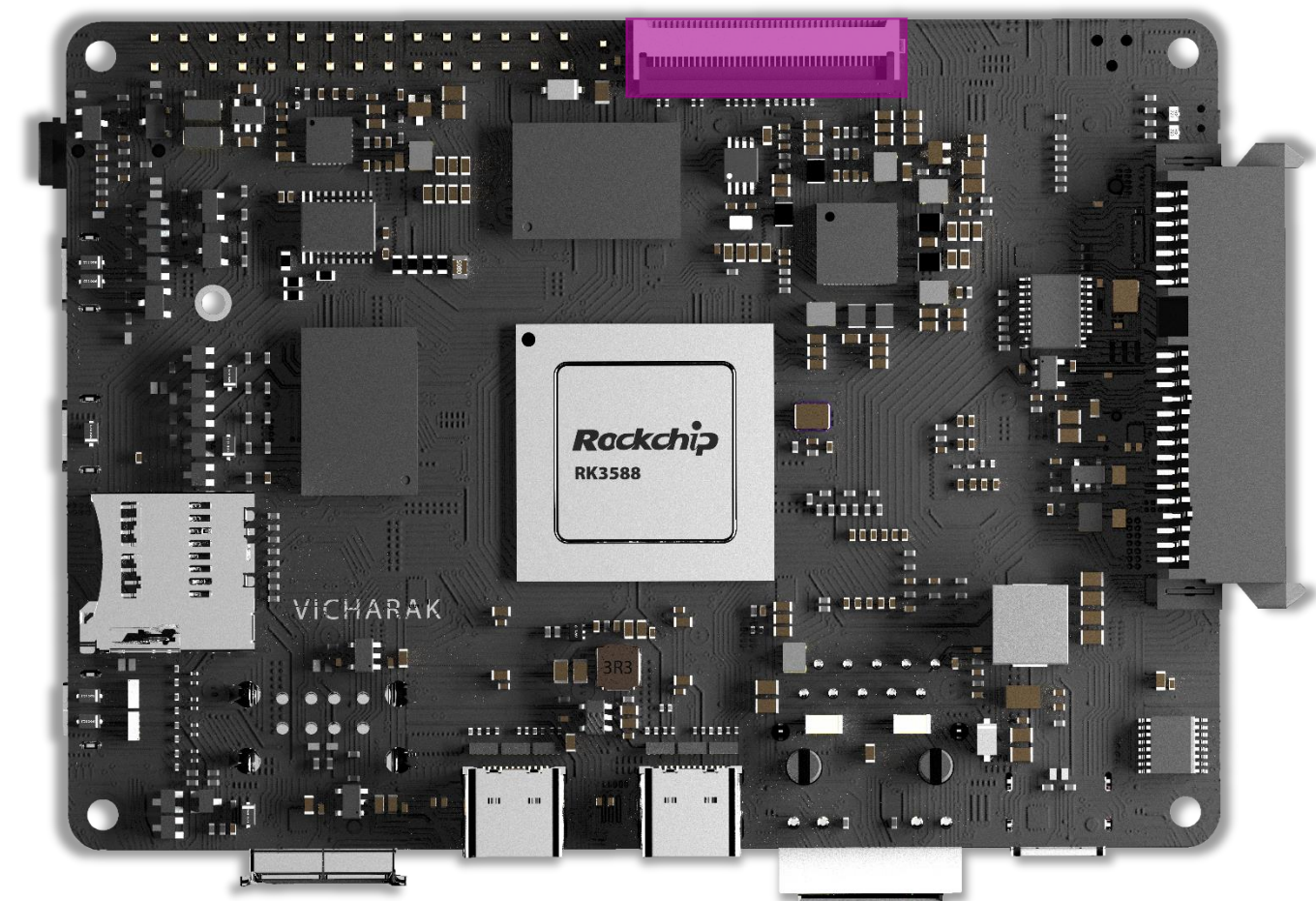
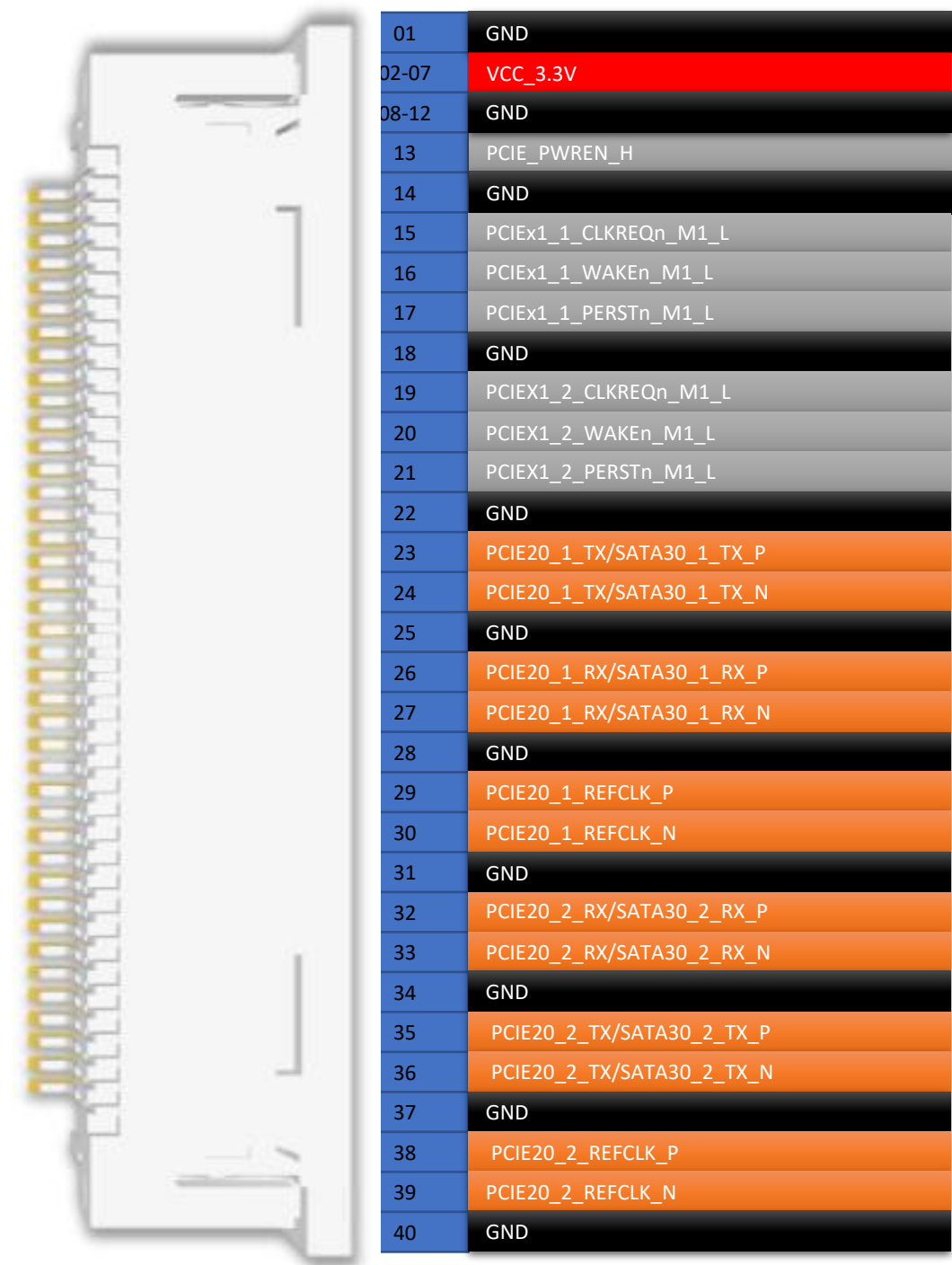

PCIe2.0/SATA3.0 FPC Connector

FPC Connector

40 Pin

0.5mm Pitch

MPN : FPC-05FB-40PH20

FPC Cable

40 Pin

0.5mm Pitch

Impedance 85 Ohm

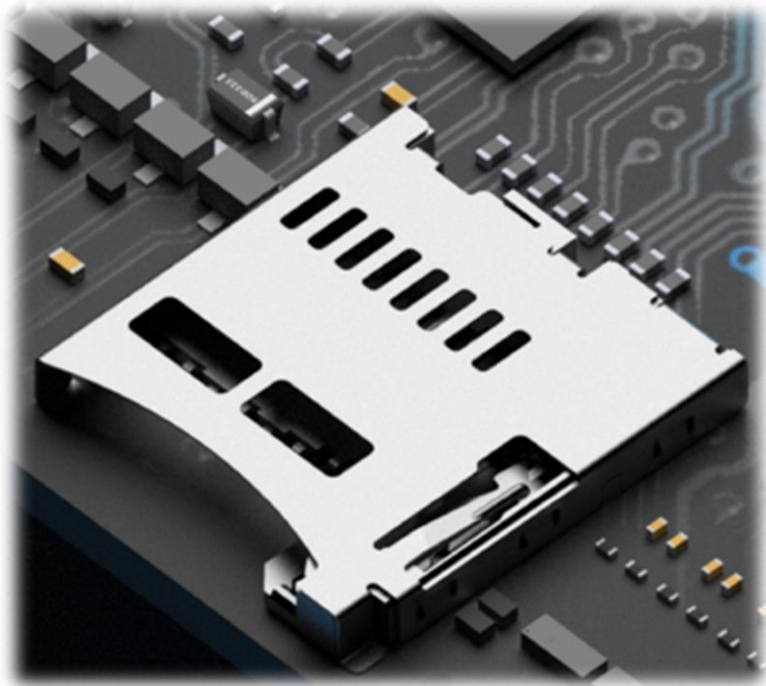

Push-Push Type MicroSD Card Slot

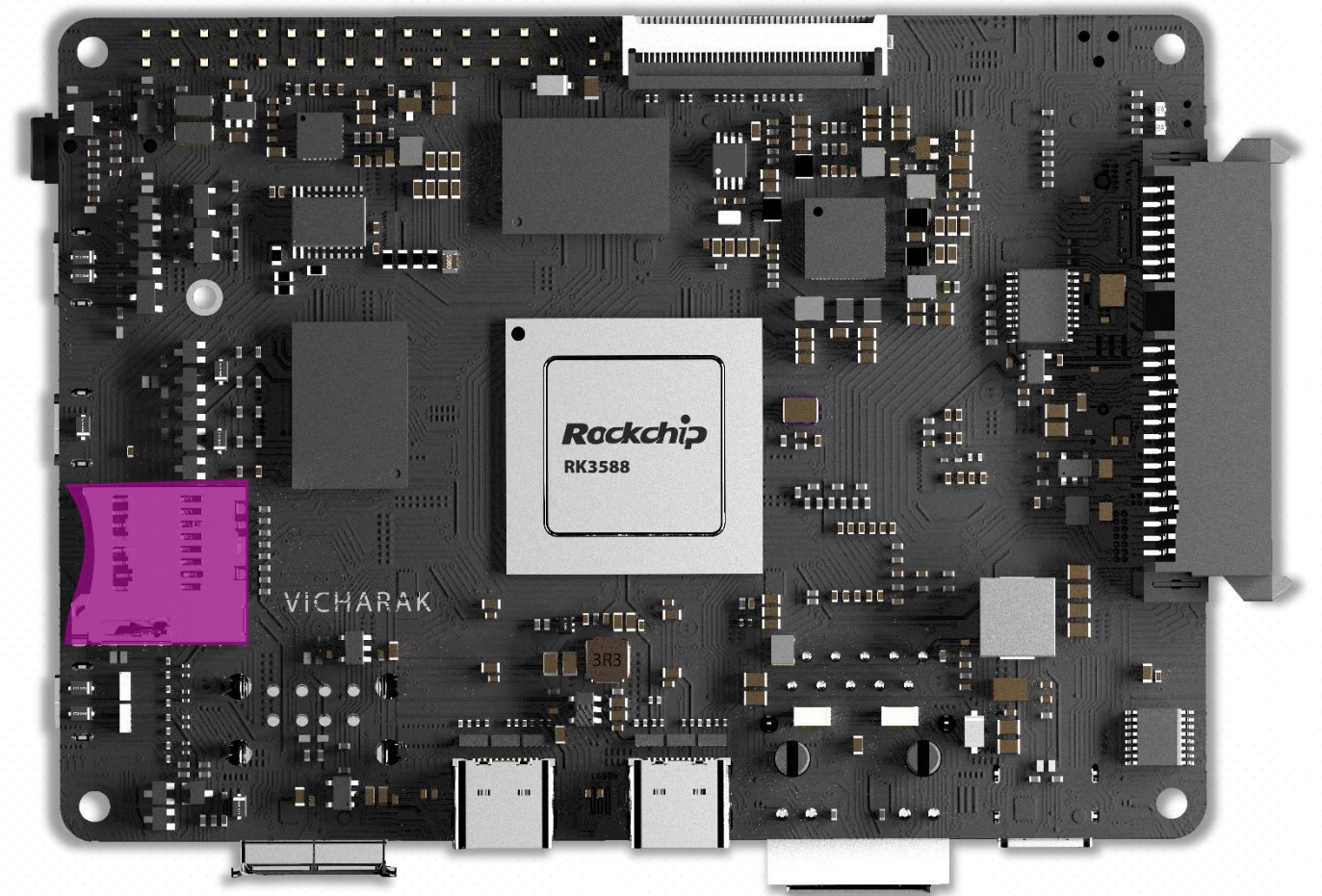



TYPE-C Alt Display Port

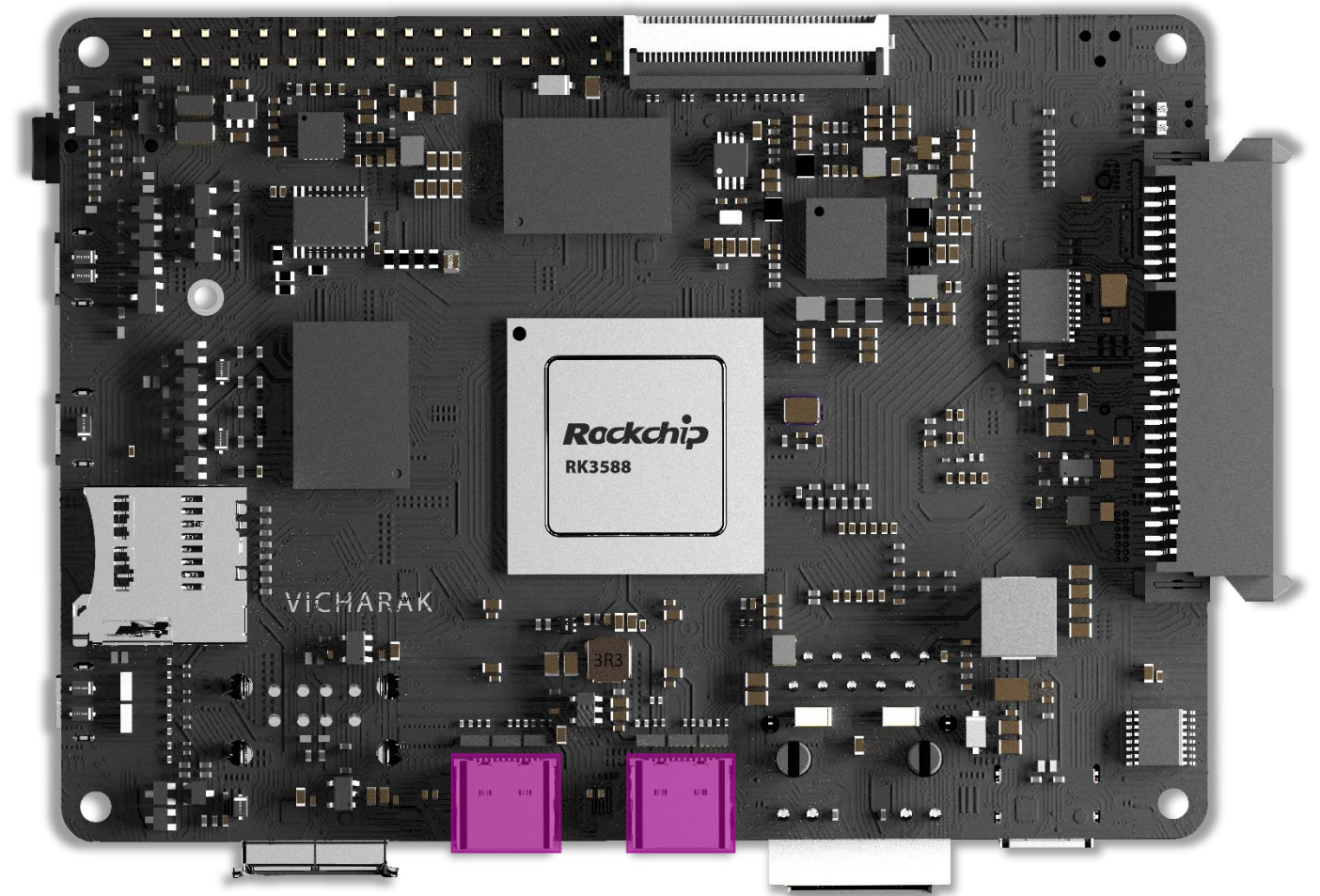

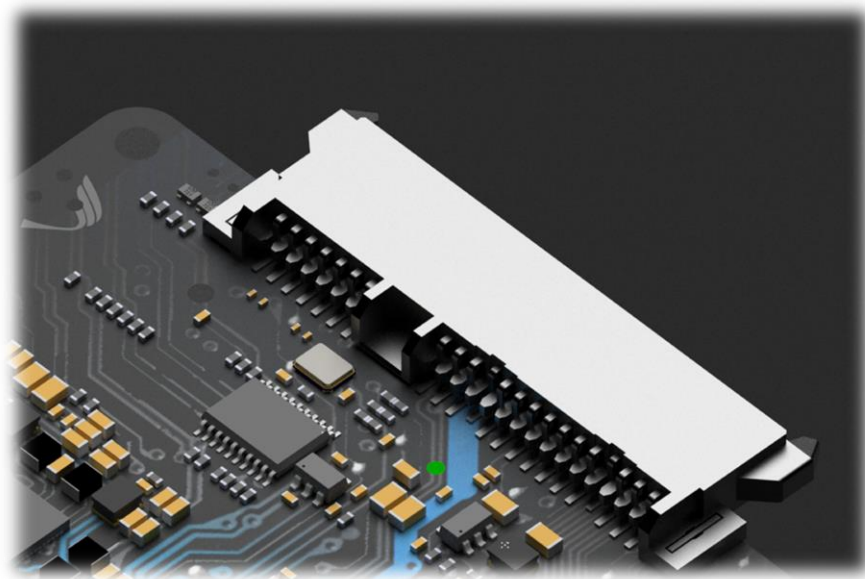

**22 Pin SATA Connector
SATA 3.0**

